

1990 Bayou 300 PARTS DIAGRAM

Drive Shaft/Final Gear

E3132

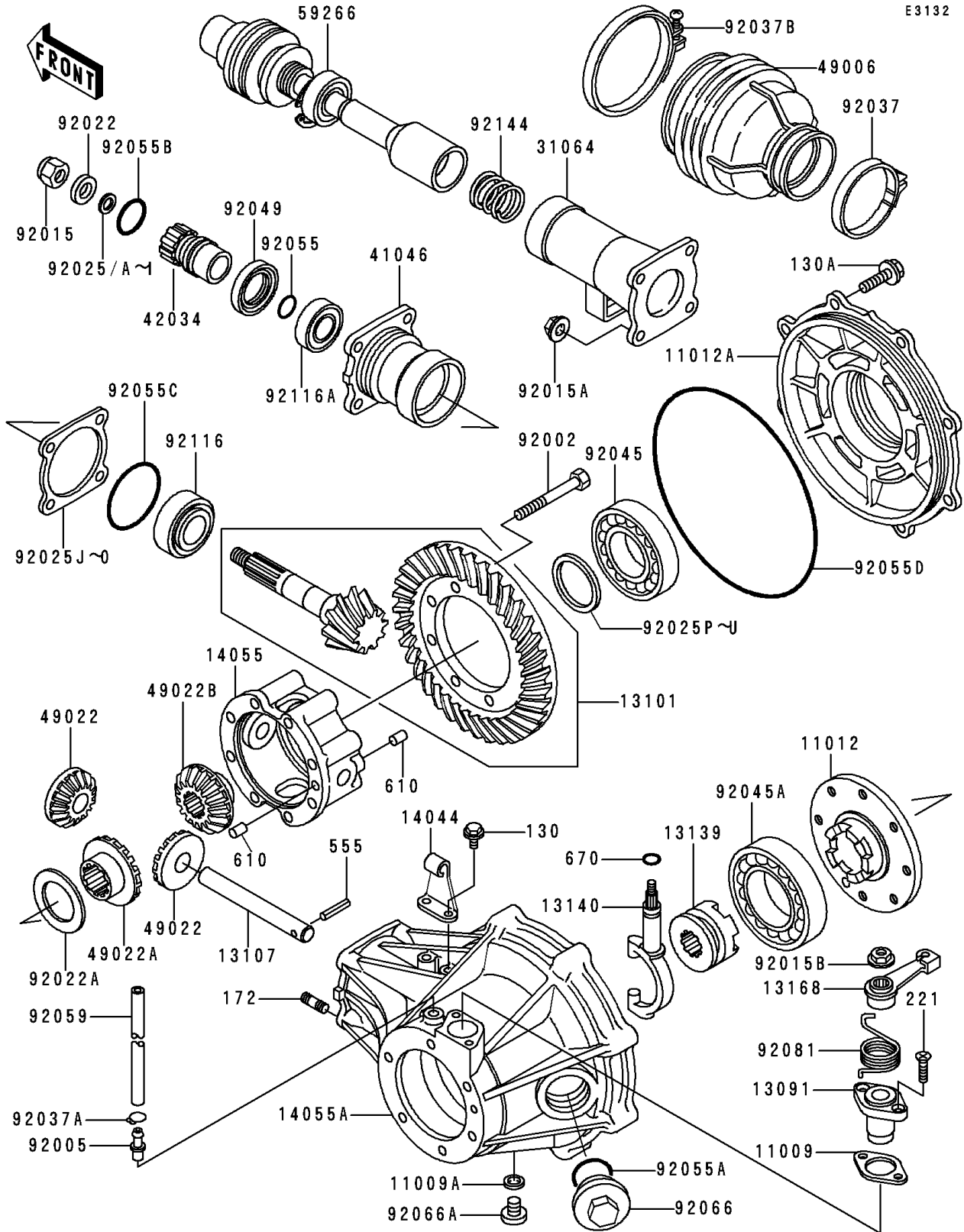

1990 Bayou 300 PARTS LIST

Drive Shaft/Final Gear

ITEM NAME	PART NUMBER	QUANTITY
GASKET (Ref # 11009)	11009-1521	1
GASKET,10.5X16X1,DRAIN PLUG (Ref # 11009A)	92065-058	1
CAP,BEVEL GEAR (Ref # 11012)	11012-1444	1
CAP,DIFFERENTIAL CASE (Ref # 11012A)	11012-1614	1
HOLDER (Ref # 13091)	13091-1375	1
GEAR-ASSY,DIFFERENTIAL CASE (Ref # 13101)	13101-5054	1
SHAFT,BEVEL GEAR (Ref # 13107)	13107-1149	1
SHIFTER (Ref # 13139)	13139-1055	1
FORK-SHIFT,DIFF LOCK (Ref # 13140)	13140-1136	1
LEVER (Ref # 13168)	13168-1268	1
HOLDER-CABLE,DIFFERENTIAL (Ref # 14044)	14044-1058	1
CASE-GEAR,BEVEL (Ref # 14055)	14055-1072	1
CASE-GEAR (Ref # 14055A)	14055-1082	1
PIPE-COMP (Ref # 31064)	31064-1093	1
HOUSING-BEARING (Ref # 41046)	41046-1065	1
COUPLING,DIFFERENTIAL CASE (Ref # 42034)	42034-1078	1
BOOT,DRIVE SHAFT (Ref # 49006)	49006-1237	1
GEAR-BEVEL,10T (Ref # 49022)	49022-1065	2
GEAR-BEVEL,OD=35,16T (Ref # 49022A)	49022-1104	1
GEAR-BEVEL,OD=30,16T (Ref # 49022B)	49022-1106	1
JOINT-BALL (Ref # 59266)	59266-1070	1
BOLT,8X68 (Ref # 92002)	92002-1553	8
FITTING,BREATHER (Ref # 92005)	92005-1127	1
NUT,12MM (Ref # 92015)	92015-1182	1
NUT,8MM (Ref # 92015A)	92015-1402	4
NUT,8MM (Ref # 92015B)	92015-1406	1
WASHER,12.3X25X3.2 (Ref # 92022)	92022-1293	1
WASHER (Ref # 92022A)	92022-1742	1
SHIM,12.5X17X1.30 (Ref # 92025)	92025-1282	AR

1990 Bayou 300 PARTS LIST

Drive Shaft/Final Gear

ITEM NAME	PART NUMBER	QUANTITY
SHIM,12.5X17X0.1 (Ref # 92025A)	92025-1287	AR
SHIM,12.5X17X0.2 (Ref # 92025B)	92025-1288	AR
SHIM,12.5X17X0.3 (Ref # 92025C)	92025-1289	AR
SHIM,12.5X17X0.5 (Ref # 92025D)	92025-1290	AR
SHIM,12.5X17X0.6 (Ref # 92025E)	92025-1291	AR
SHIM,12.5X17X0.7 (Ref # 92025F)	92025-1292	AR
SHIM,12.5X17X0.8 (Ref # 92025G)	92025-1293	AR
SHIM,12.5X17X0.9 (Ref # 92025H)	92025-1294	AR
SHIM,12.5X17X1.0 (Ref # 92025I)	92025-1295	AR
SHIM,T=0.10 (Ref # 92025J)	92025-1703	AR
SHIM,T=0.15 (Ref # 92025K)	92025-1704	AR
BOLT-FLANGED (Ref # 130)	130D0610	2
BOLT-FLANGED,8X25 (Ref # 130A)	130G0825	8
BOLT-STUD,8X25 (Ref # 172)	172G0825	4
SCREW-CSK-CROS,6X18 (Ref # 221)	221B0618	2
PIN-SPRING (Ref # 555)	555A0528	1
ROLLER,8X12 (Ref # 610)	610A0812	2
O RING,10MM (Ref # 670)	670B2010	1
SHIM,T=0.50 (Ref # 92025L)	92025-1705	AR
SHIM,T=0.80 (Ref # 92025M)	92025-1706	AR
SHIM,T=1.00 (Ref # 92025N)	92025-1707	AR
SHIM,T=1.20 (Ref # 92025O)	92025-1708	AR
SHIM,40.5X50X0.10 (Ref # 92025P)	92025-1709	AR
SHIM,40.5X50X0.15 (Ref # 92025Q)	92025-1710	AR
SHIM,40.5X50X0.50 (Ref # 92025R)	92025-1711	AR
SHIM,40.5X50X0.80 (Ref # 92025S)	92025-1712	AR
SHIM,40.5X50X1.00 (Ref # 92025T)	92025-1713	AR
SHIM,40.5X50X1.20 (Ref # 92025U)	92025-1714	AR
CLAMP (Ref # 92037)	92037-1523	1

1990 Bayou 300 PARTS LIST

Drive Shaft/Final Gear

ITEM NAME	PART NUMBER	QUANTITY
CLAMP (Ref # 92037A)	92037-1610	1
CLAMP (Ref # 92037B)	92037-1654	1
BEARING-BALL,6208CM (Ref # 92045)	92045-1145	1
BEARING-BALL (Ref # 92045A)	92045-1213	1
SEAL-OIL (Ref # 92049)	92049-1231	1
RING-O,17.5X1.5 (Ref # 92055)	92055-022	1
RING-O,36MM (Ref # 92055A)	92055-1005	1
RING-O,27MM (Ref # 92055B)	92055-1119	1
RING-O,54.8MM (Ref # 92055C)	92055-1296	1
RING-O,179.8MM (Ref # 92055D)	92055-1297	1
TUBE,6X9X1050 (Ref # 92059)	92059-1939	1
PLUG,OIL FILLER CAP,M.SILVER (Ref # 92066)	92066-1006-7J	1
PLUG,DRAIN,10X12 (Ref # 92066A)	92067-001	1
SPRING (Ref # 92081)	92081-1853	1
BEARING-ROLLER,4T-CR-0566 (Ref # 92116)	92116-1005	1
BEARING-ROLLER,4T32004X (Ref # 92116A)	92116-1010	1
SPRING,DRIVE SHAFT (Ref # 92144)	92144-1235	1