

1980 KE125 PARTS DIAGRAM

CRANKSHAFT/PISTON/ROTARY VALVE ('80-'81)

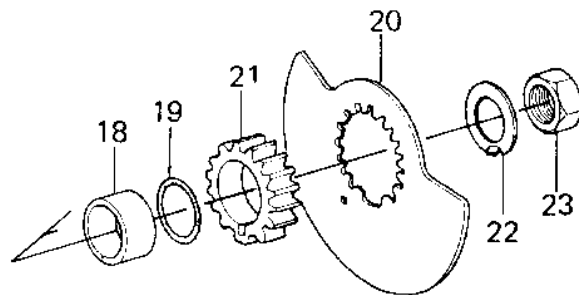
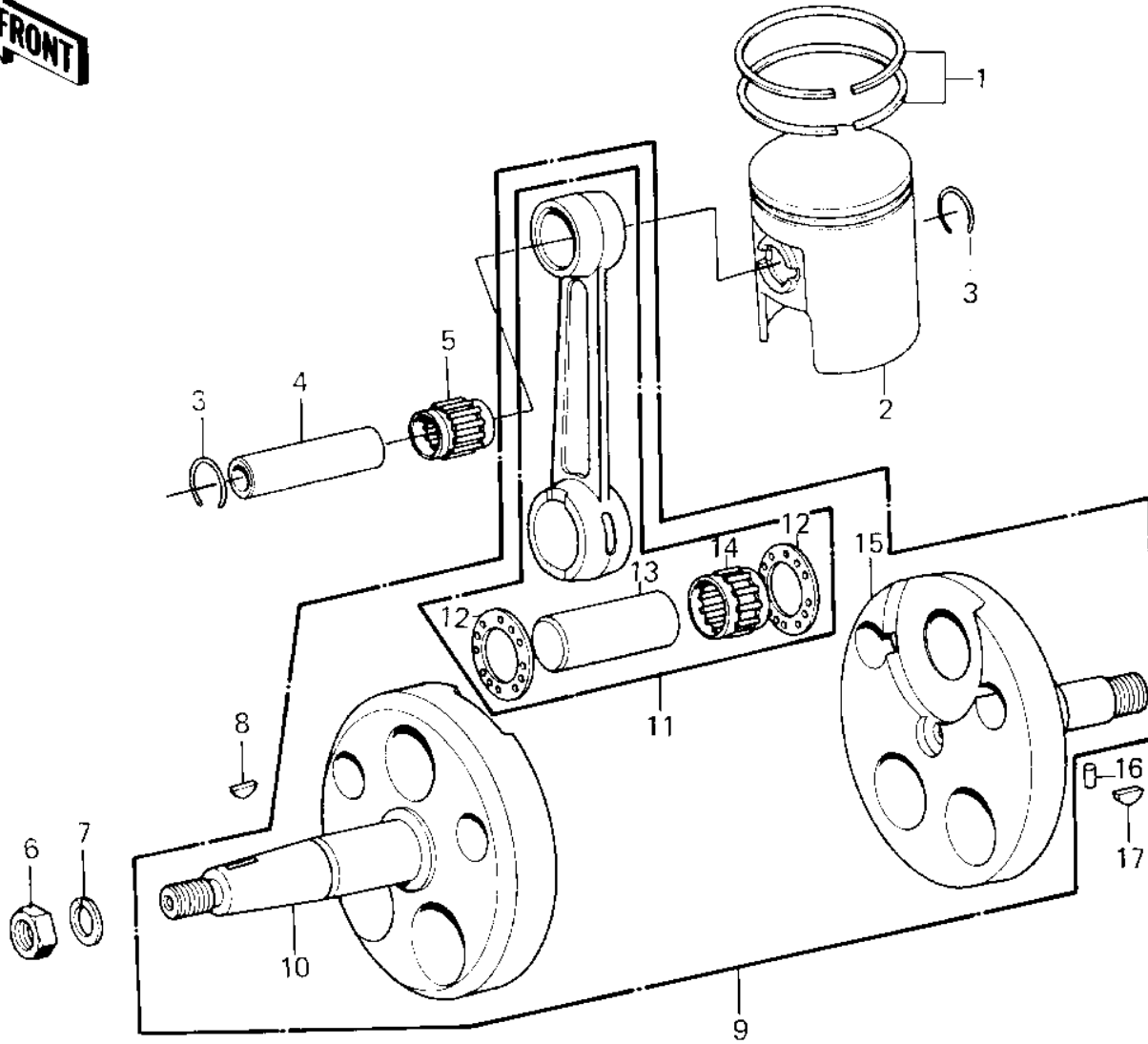

1980 KE125 PARTS LIST

CRANKSHAFT/PISTON/ROTARY VALVE ('80-'81)

ITEM NAME	PART NUMBER	QUANTITY
RING-SET,PISTON,S.T.D (Ref # 1)	13008-5010	1
PISTON-ENGINE,STD (Ref # 2)	13001-1124	1
CIRCLIP PISTON PIN (Ref # 3)	92036-003	2
PIN-PISTON (Ref # 4)	13002-1002	1
BRG,N,UR14/20AP-1 (Ref # 5)	13033-035	1
NUT,10MM (Ref # 6)	314B1000	1
WASHER SPRING 10MM (Ref # 7)	461F1000	1
WOODRUFF KEY (Ref # 8)	510A3200	1
CRANK AND CONROD ASSY (Ref # 9)	13031-1003	1
CRANKSHAFT,L.H (Ref # 10)	13037-059	1
CONNECTING ROD SET (Ref # 11)	13044-5003	1
WASHER SIDE (Ref # 12)	92025-005	2
CRANK PIN (Ref # 13)	13035-033	1
BRG,NEEDLE,KT202715EG (Ref # 14)	13034-1001	1
CRANKSHAFT,R.H. (Ref # 15)	13037-1084	1
PIN DOWEL 4X10 (Ref # 16)	610A0410	1
WOODRUFF KEY PRY PINI (Ref # 17)	92038-003	1
COLLAR,ENG SPROCKET (Ref # 18)	92027-1077	1
"O" RING,16MM (Ref # 19)	670B2016	1
VALVE,ROTARY DISC (Ref # 20)	12002-029	1
COLLAR,ROTARY DISC (Ref # 21)	92027-1272	1
WASHER LOCK 12MM (Ref # 22)	92024-003	1
NUT 12MM (Ref # 23)	92015-006	1