

# 2012 NINJA® ZX™-6R

## PARTS DIAGRAM

### Valve(s)

E1210

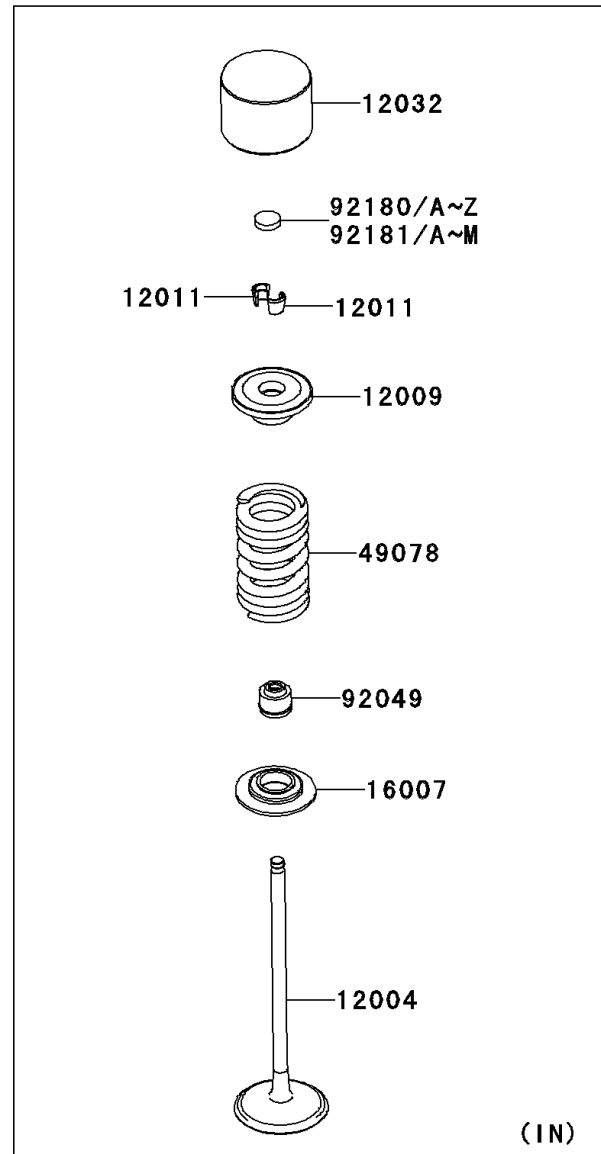
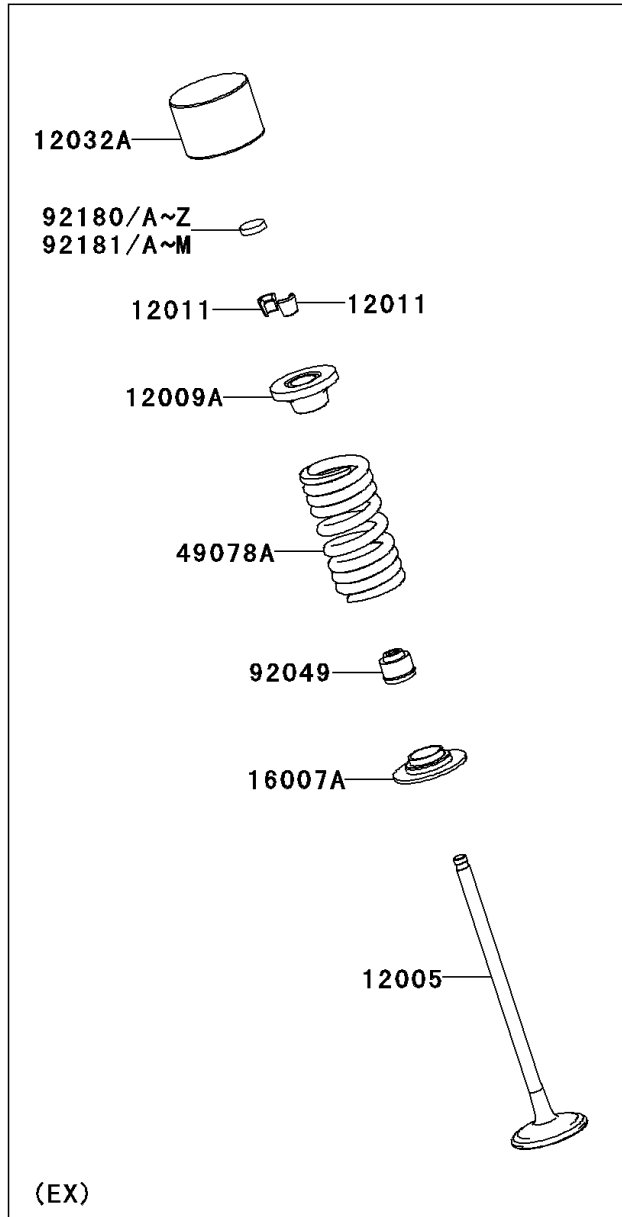

# 2012 NINJA® ZX™ -6R

## PARTS LIST

Valve(s)

**ITEM NAME**

**PART NUMBER**

**QUANTITY**

---