

# 2012 NINJA® ZX™-14R

## PARTS DIAGRAM

### Side Covers/Chain Cover

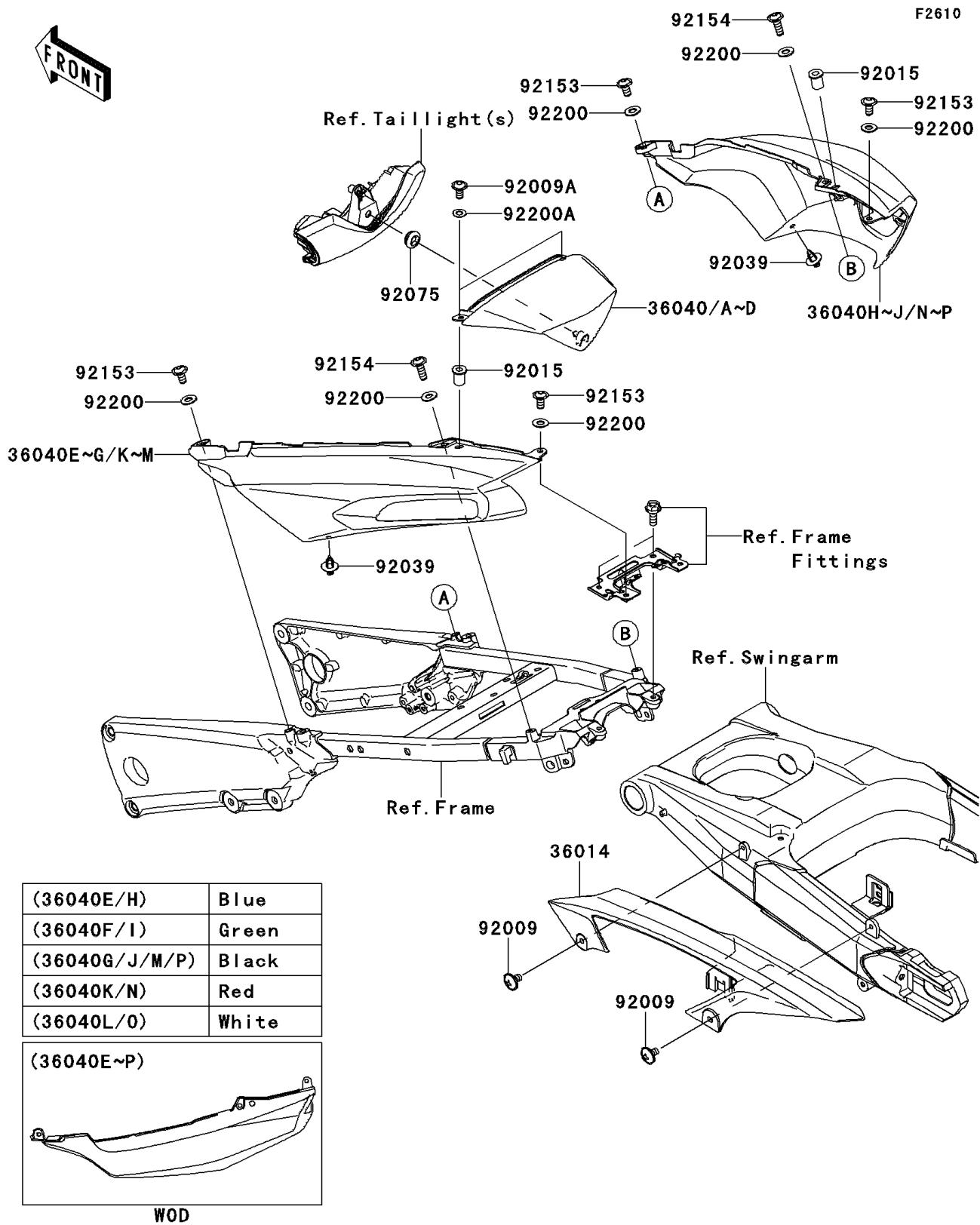

# 2012 NINJA® ZX™-14R

## PARTS LIST

### Side Covers/Chain Cover

**ITEM NAME**

**PART NUMBER**

**QUANTITY**

---