

2006 KLX110

PARTS DIAGRAM

Rear Suspension

F2150

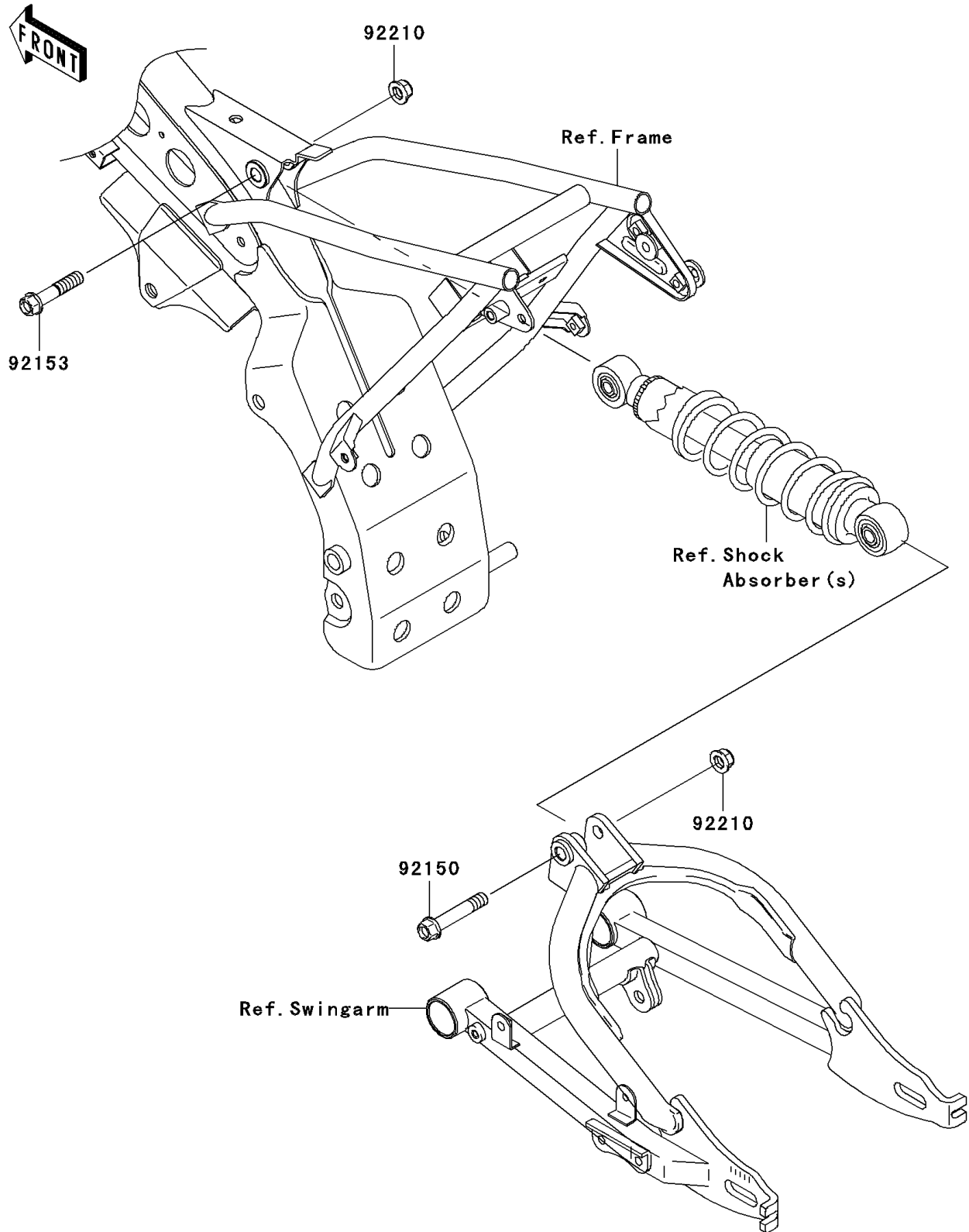

2006 KLX110

PARTS LIST

Rear Suspension

ITEM NAME

PART NUMBER

QUANTITY
