

2008 KX™ 450F

PARTS DIAGRAM

Labels

F2860

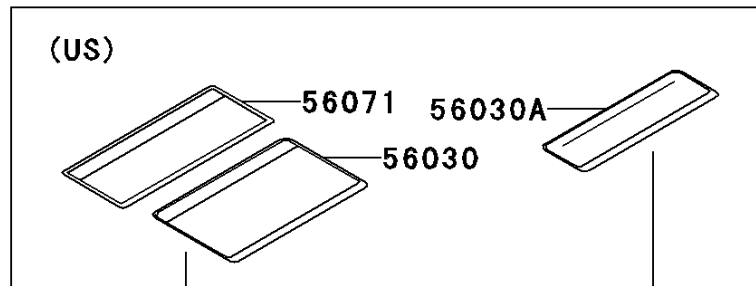
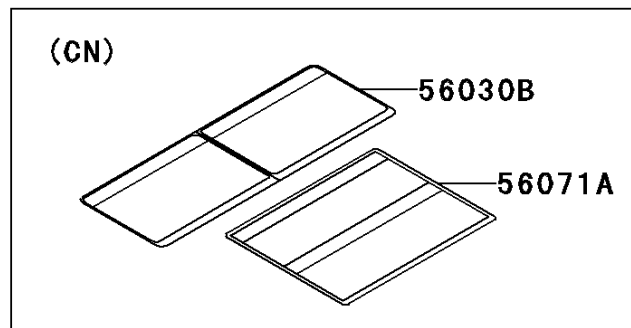

Ref. Fenders

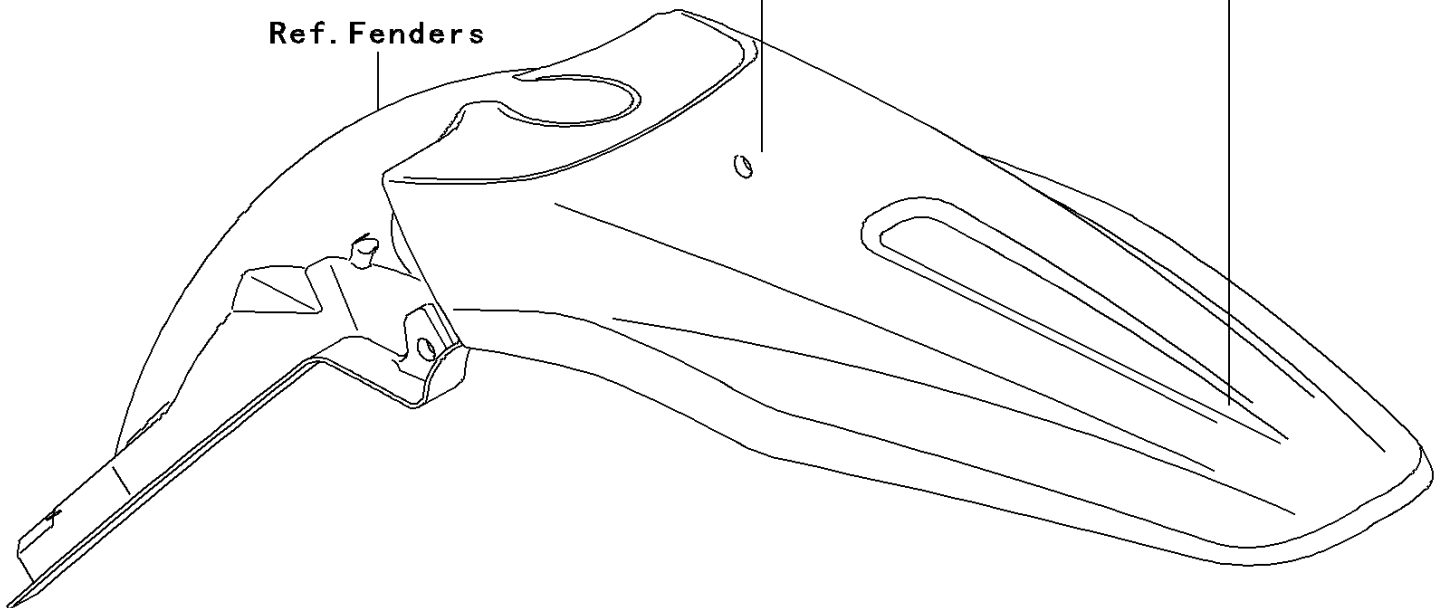

2008 KX™ 450F

PARTS LIST

Labels

ITEM NAME

PART NUMBER

QUANTITY
