

2008 KX™ 450F

PARTS DIAGRAM

Owner's Tools

F2810

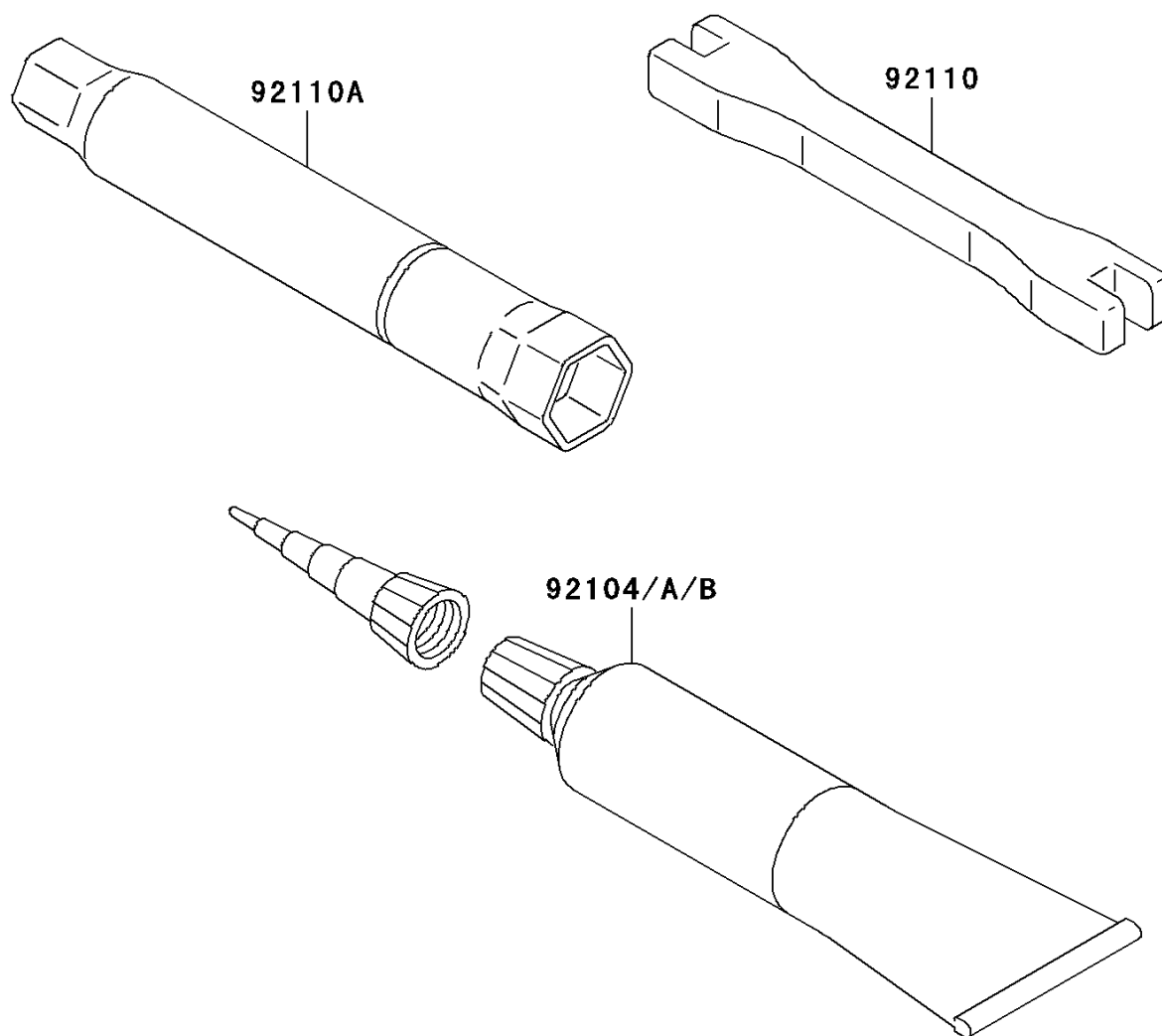

2008 KX™ 450F

PARTS LIST

Owner's Tools

ITEM NAME

PART NUMBER

QUANTITY
