

2008 KX™ 450F

PARTS DIAGRAM

Oil Pump

E1712

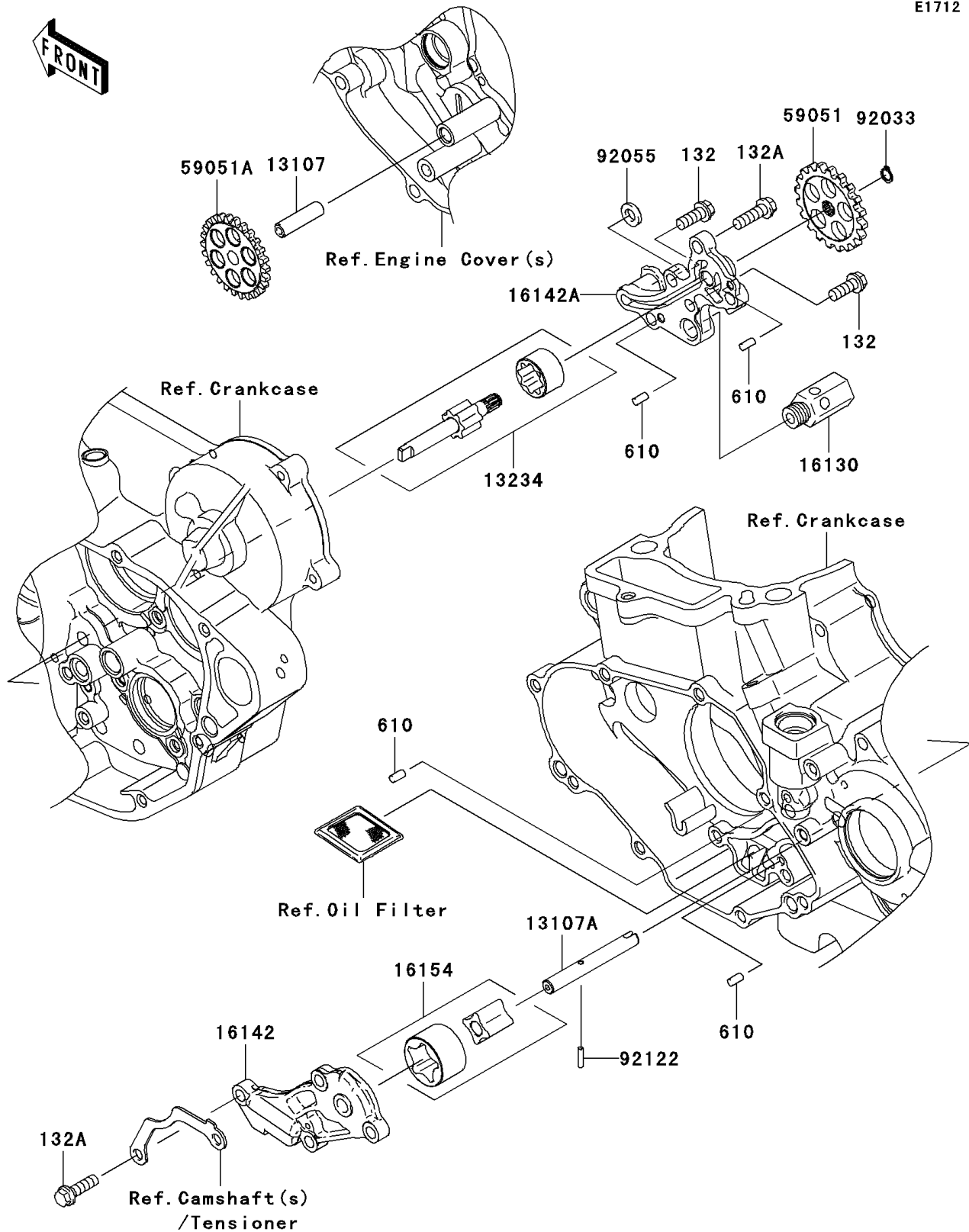

2008 KX™ 450F

PARTS LIST

Oil Pump

ITEM NAME

PART NUMBER

QUANTITY
