

2012 CONCOURS® 14 ABS

PARTS DIAGRAM

Cables



F2540

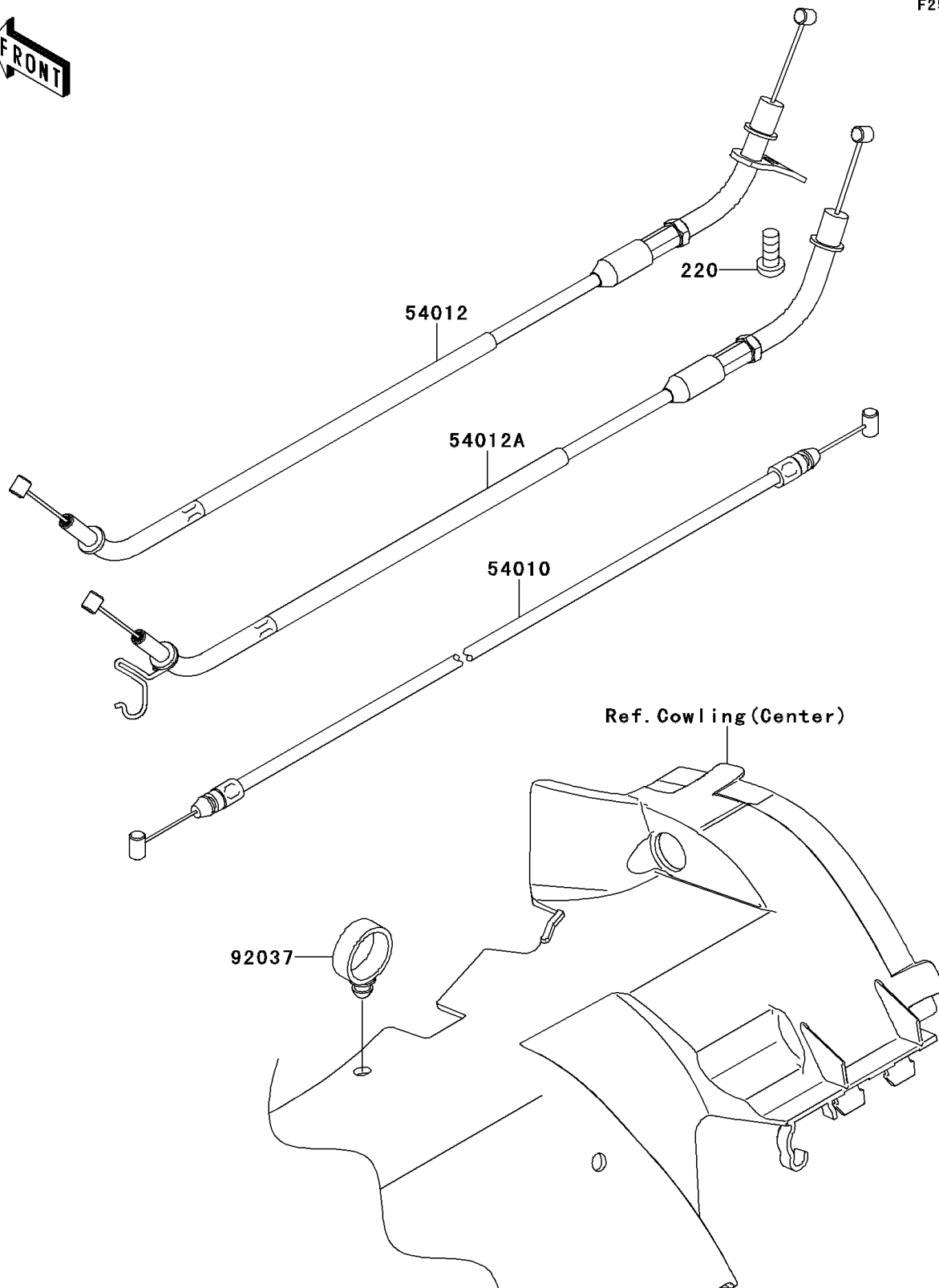

2012 CONCOURS® 14 ABS

PARTS LIST

Cables

ITEM NAME

PART NUMBER

QUANTITY
