

# 2011 KLX<sup>®</sup>110L

## PARTS DIAGRAM

### Cables

F2540

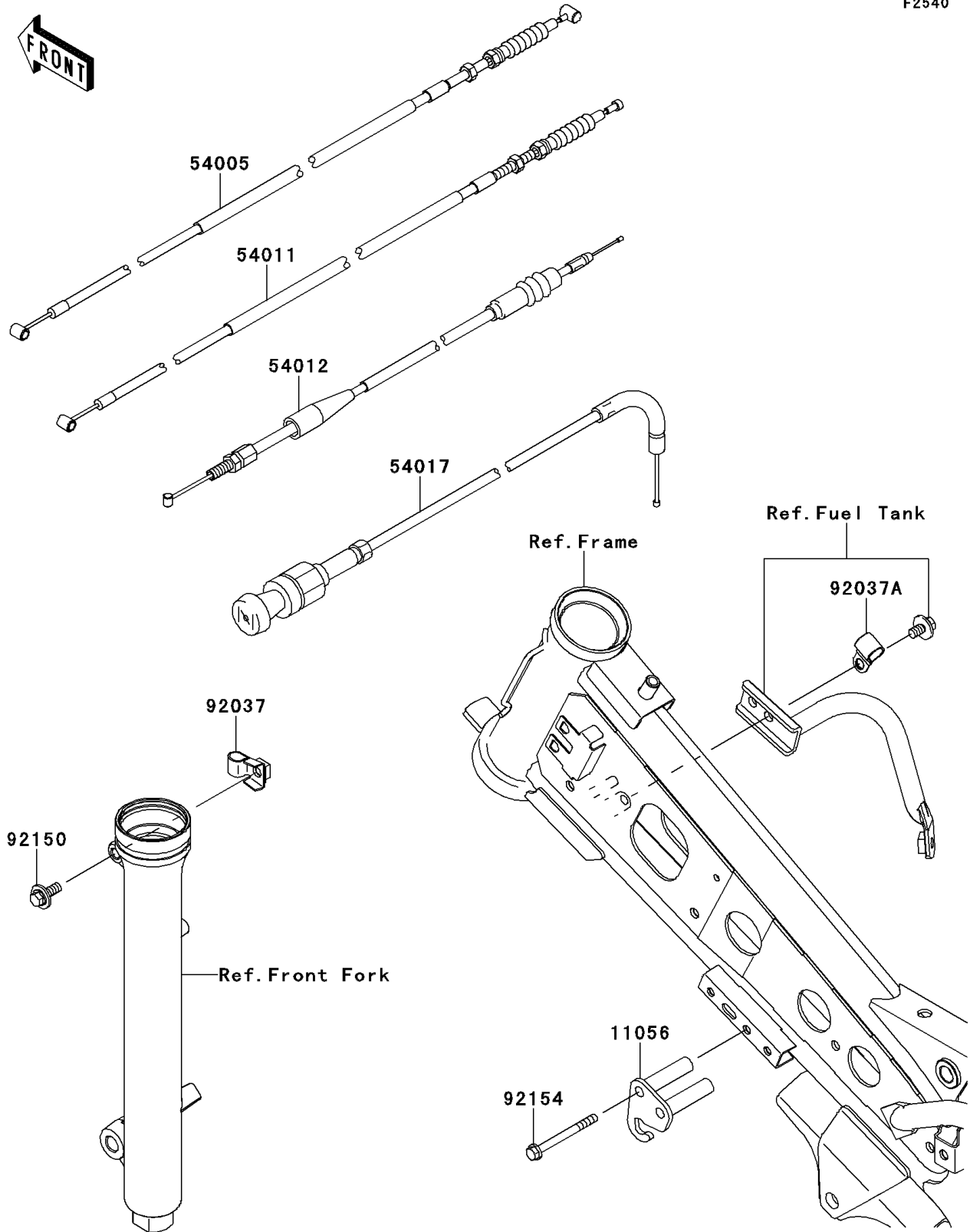

# 2011 KLX<sup>®</sup>110L

## PARTS LIST

### Cables

**ITEM NAME**

**PART NUMBER**

**QUANTITY**

---