

# 2008 KX™ 250F

## PARTS DIAGRAM

Labels

F2860

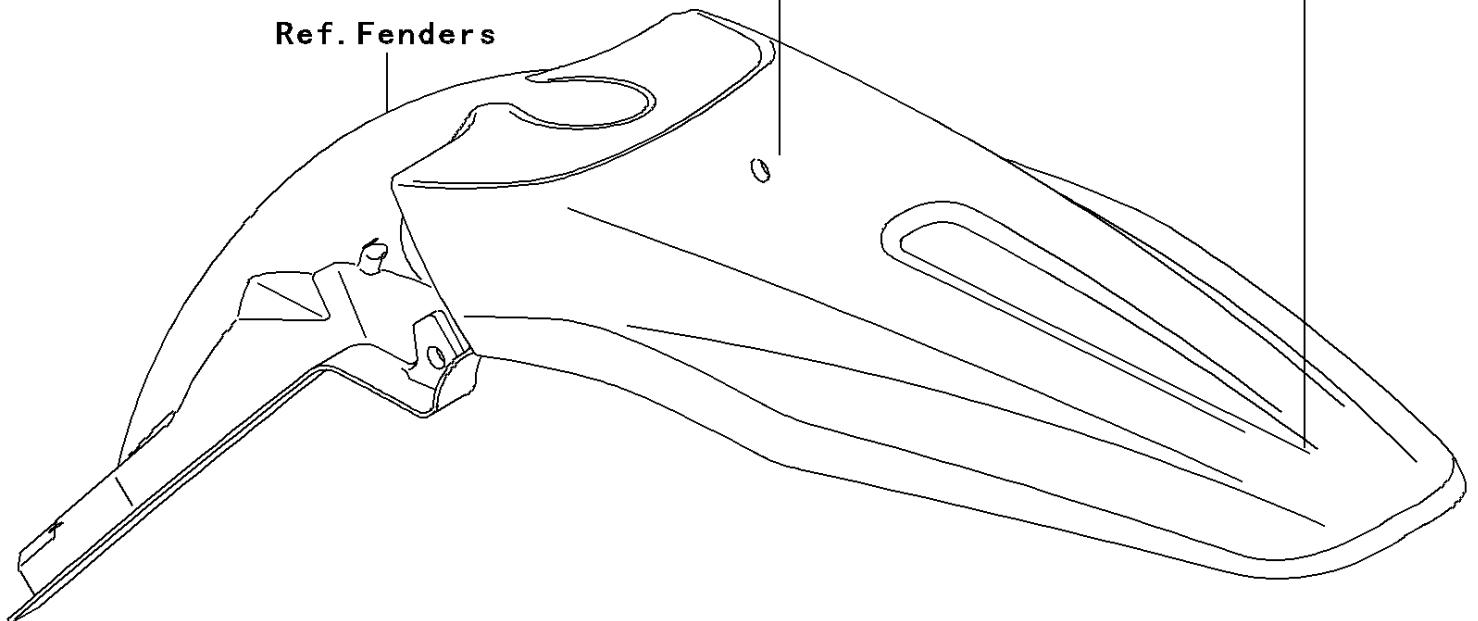
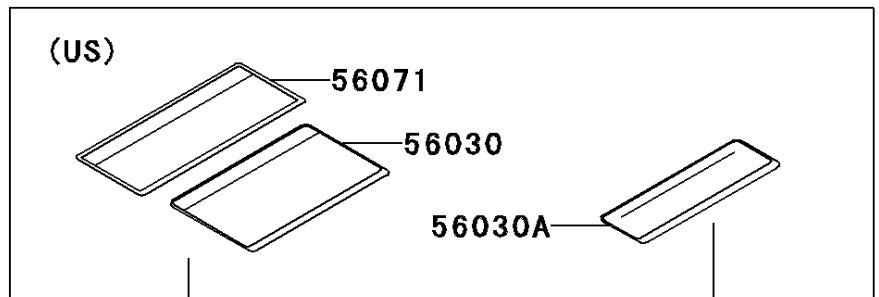
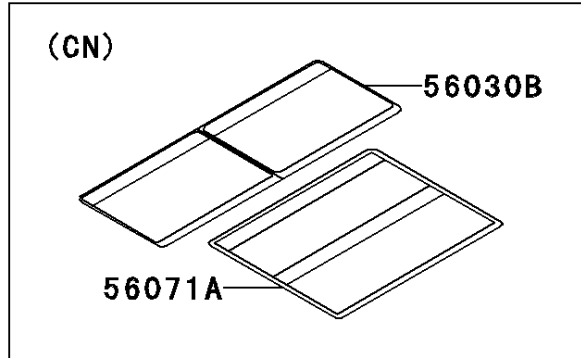

# 2008 KX™ 250F

## PARTS LIST

### Labels

**ITEM NAME**

**PART NUMBER**

**QUANTITY**

---