

# 2008 KX™ 250F

## PARTS DIAGRAM

### Oil Pump

E1710

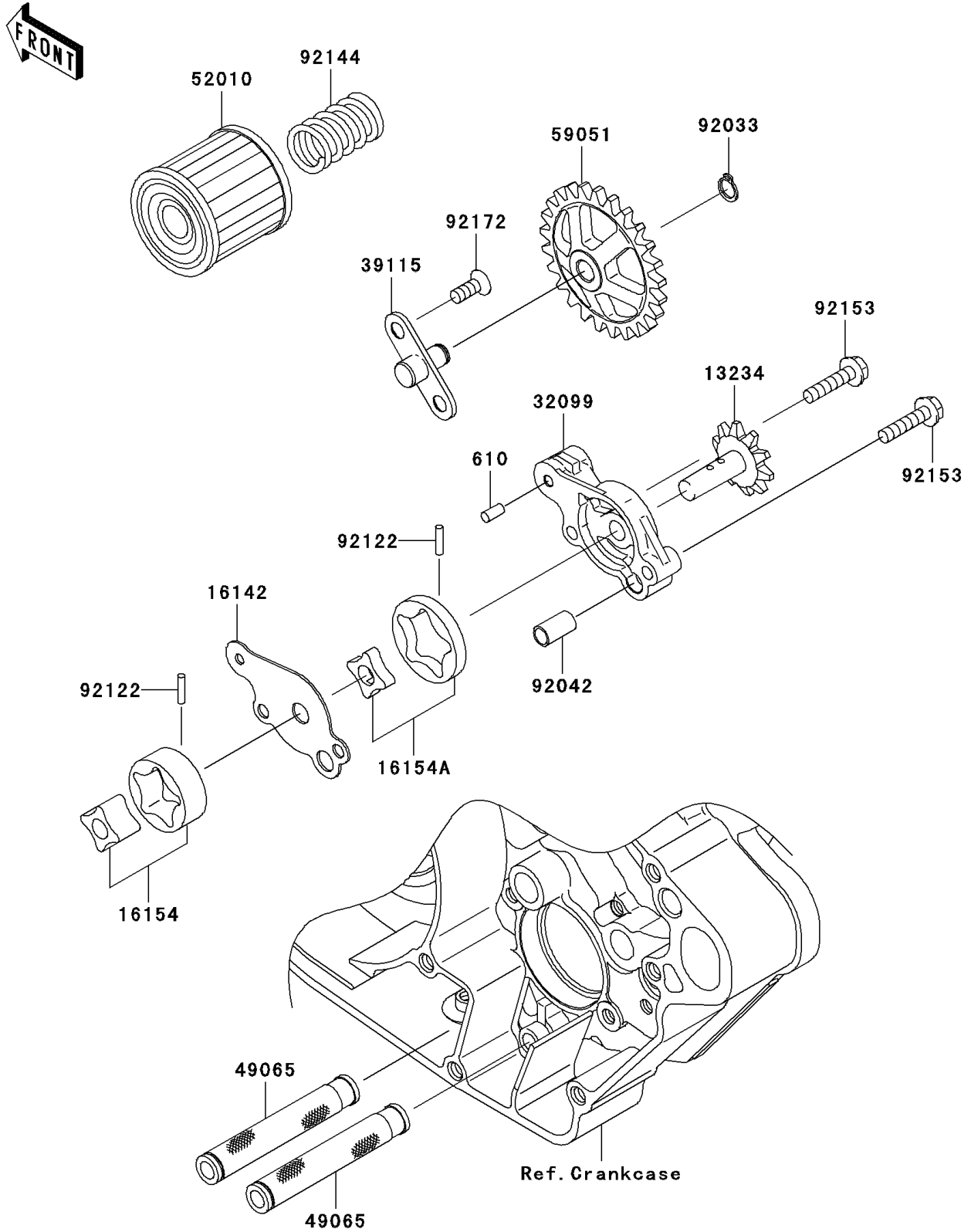

# 2008 KX™ 250F

## PARTS LIST

### Oil Pump

**ITEM NAME**

**PART NUMBER**

**QUANTITY**

---