

Mule 2510 4X4

PARTS DIAGRAM

Crankshaft/Piston(s)

E1320

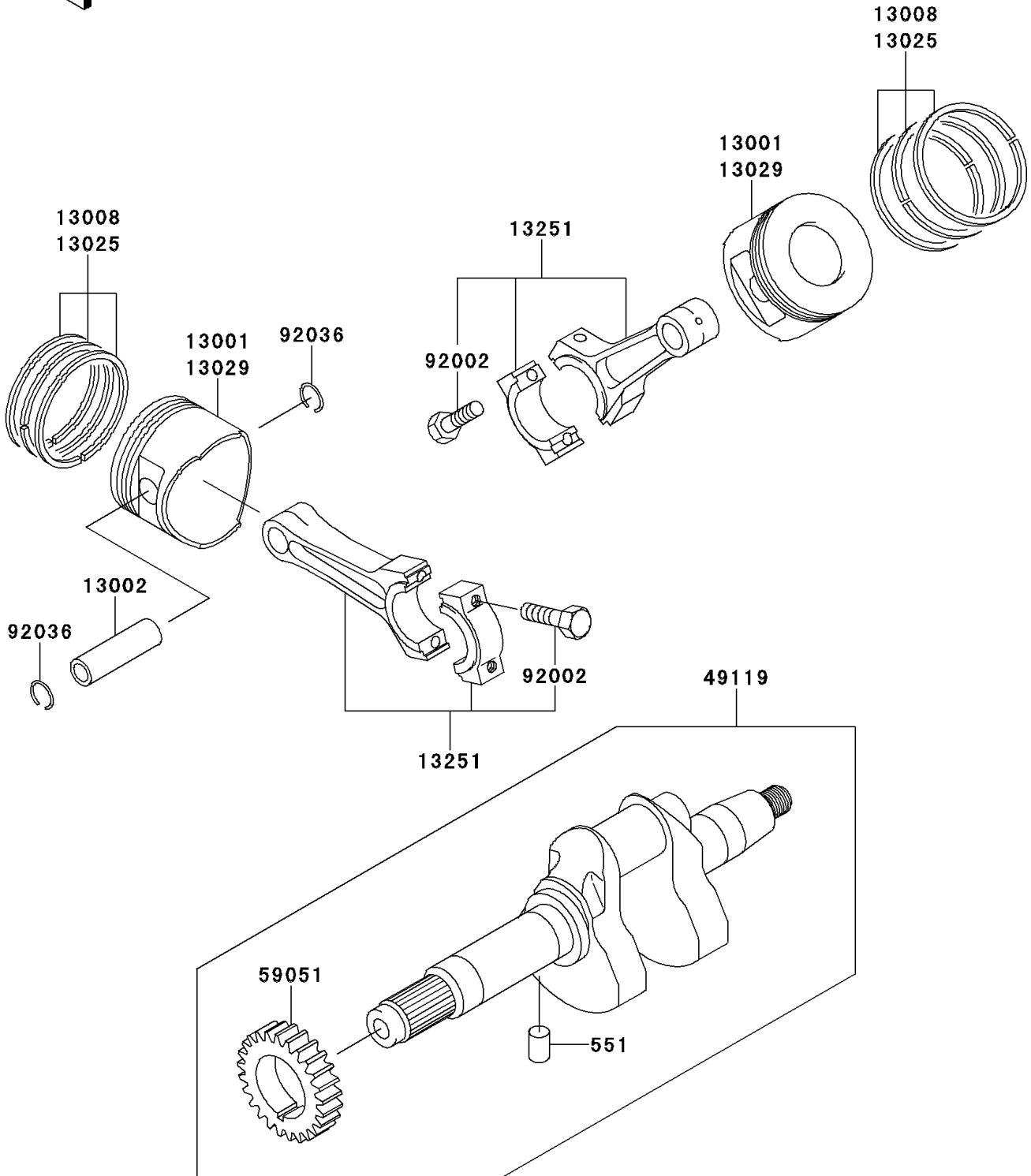

Mule 2510 4X4

PARTS LIST

Crankshaft/Piston(s)

Kawasaki

Let the Good Times Roll®

ITEM NAME	PART NUMBER	QUANTITY
PIN-DOWEL,4X8 (Ref # 551)	551A0408	1
PISTON-ENGINE,STD (Ref # 13001)	13001-2131	2
PIN-PISTON (Ref # 13002)	13002-1013	2
RING-SET-PISTON,STD (Ref # 13008)	13008-6025	2
RING-SET-PISTON L,0.50 (Ref # 13025)	13025-6008	AR
PISTON-ENGINE L,0.50 (Ref # 13029)	13029-2105	AR
ROD-ASSY-CONNECTING (Ref # 13251)	13251-6022	2
CRANKSHAFT-ASSY (Ref # 49119)	49119-2189	1
GEAR-SPUR (Ref # 59051)	59051-2112	1
BOLT (Ref # 92002)	92002-2053	4
RING-SNAP,PISTON PIN (Ref # 92036)	92036-021	4