

# 2013 KLX<sup>®</sup>110

## PARTS DIAGRAM

### Valve(s)

E1210

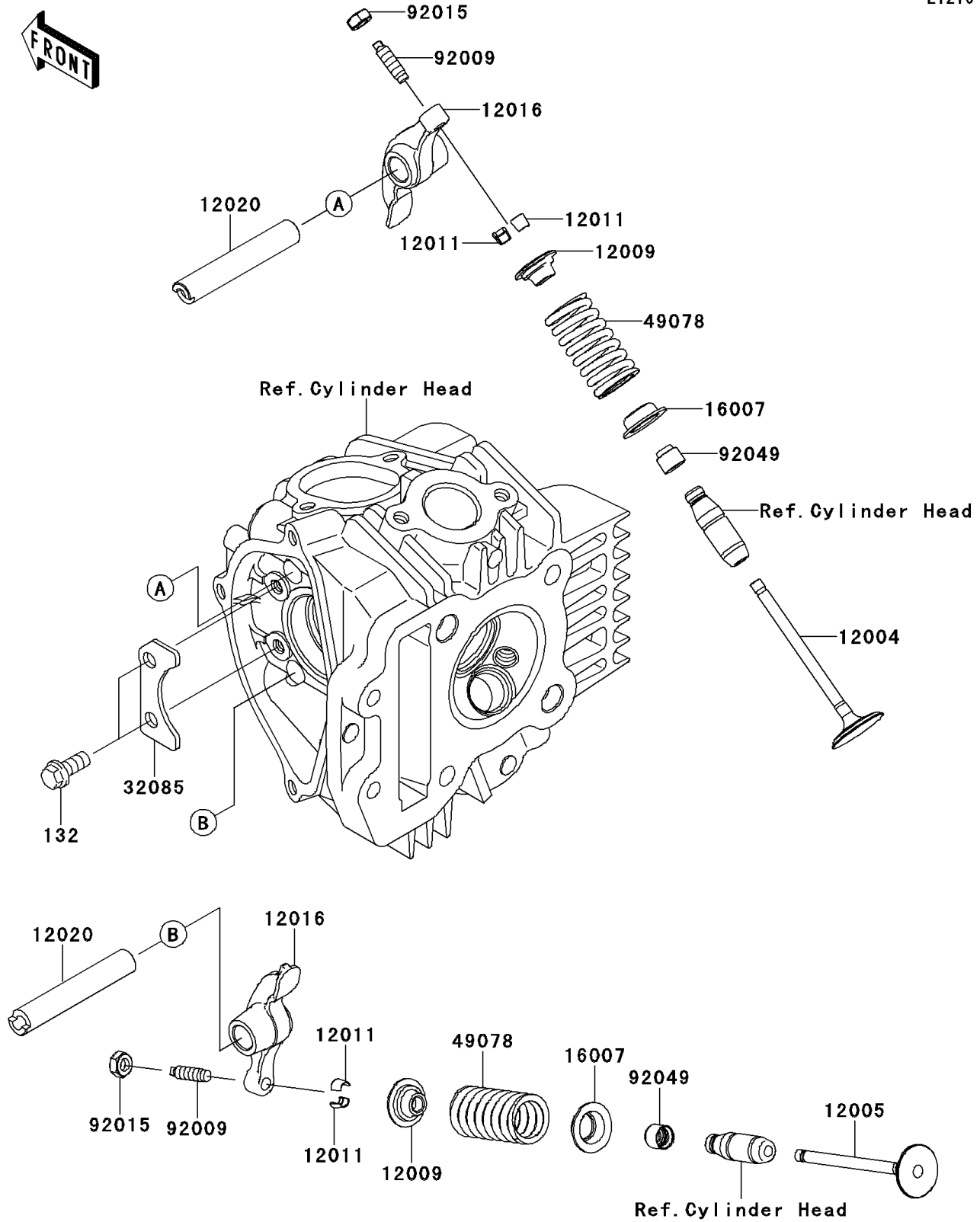

# 2013 KLX<sup>®</sup>110

## PARTS LIST

Valve(s)

**ITEM NAME**

**PART NUMBER**

**QUANTITY**

---