

2010 KX™ 250F

PARTS DIAGRAM

Oil Pump

E1710

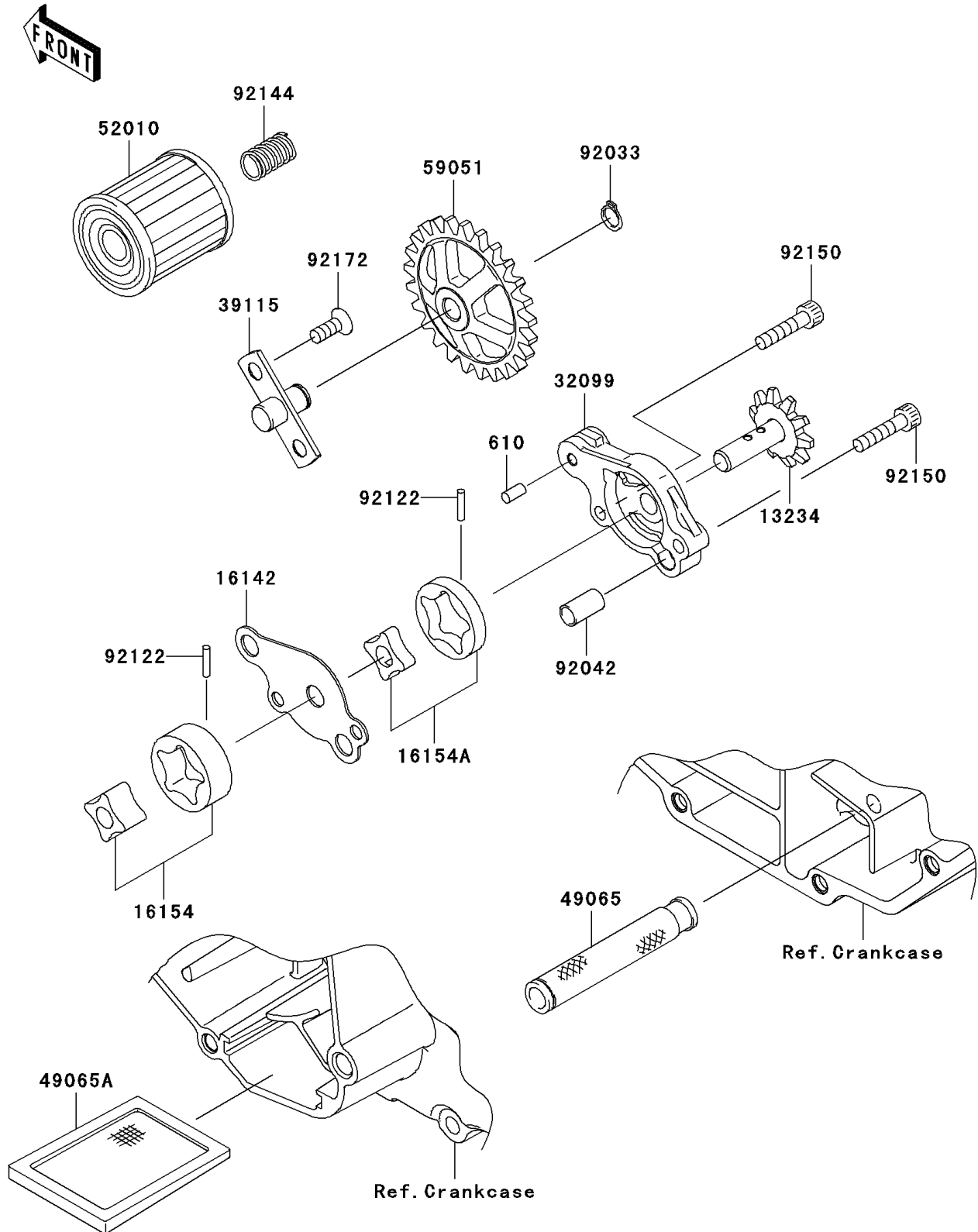

2010 KX™ 250F

PARTS LIST

Oil Pump

ITEM NAME

PART NUMBER

QUANTITY
