

2010 KX™ 250F

PARTS DIAGRAM

Valve(s)

E1210

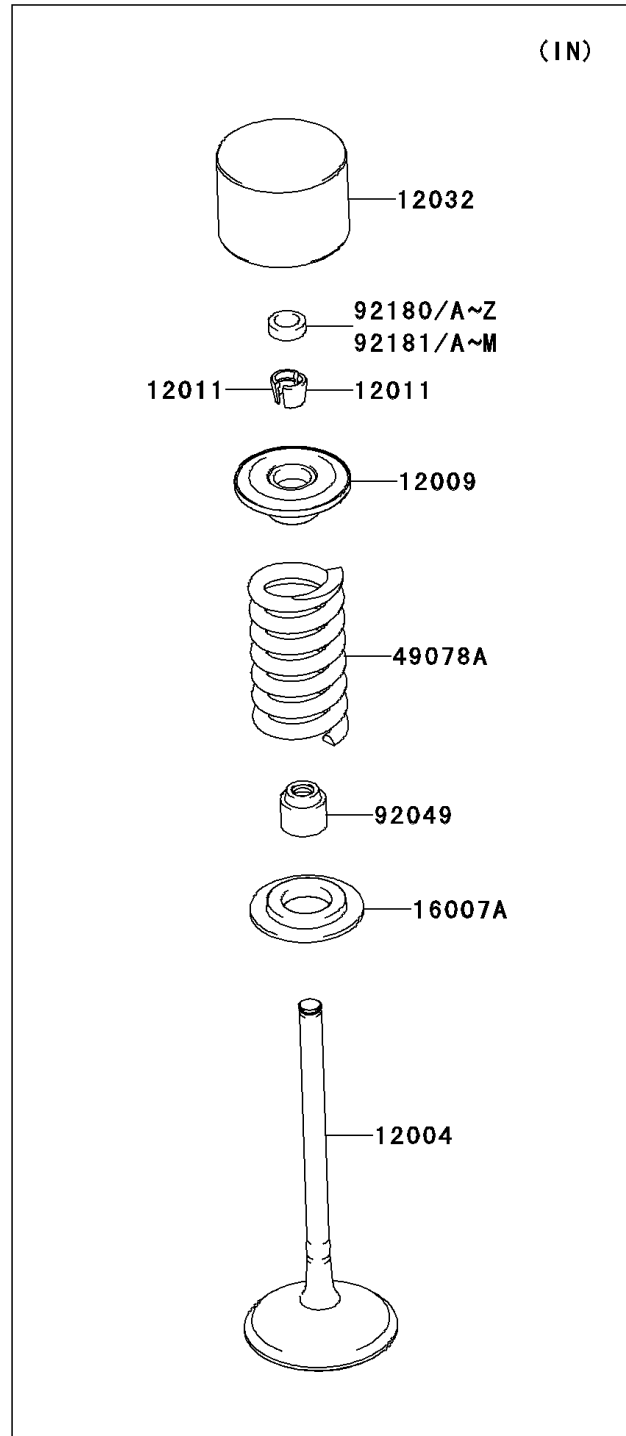
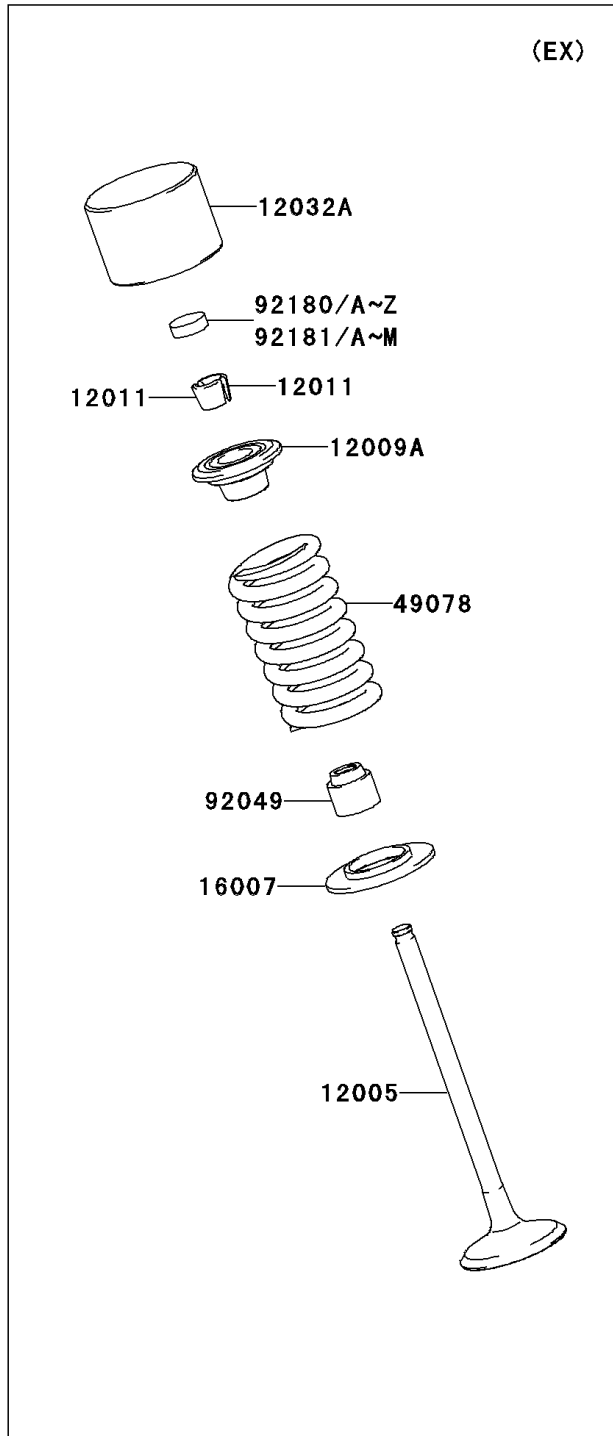

2010 KX™ 250F

PARTS LIST

Valve(s)

ITEM NAME

PART NUMBER

QUANTITY
