

# 2011 VULCAN® 900 CLASSIC LT

## PARTS DIAGRAM

### Side Covers/Chain Cover

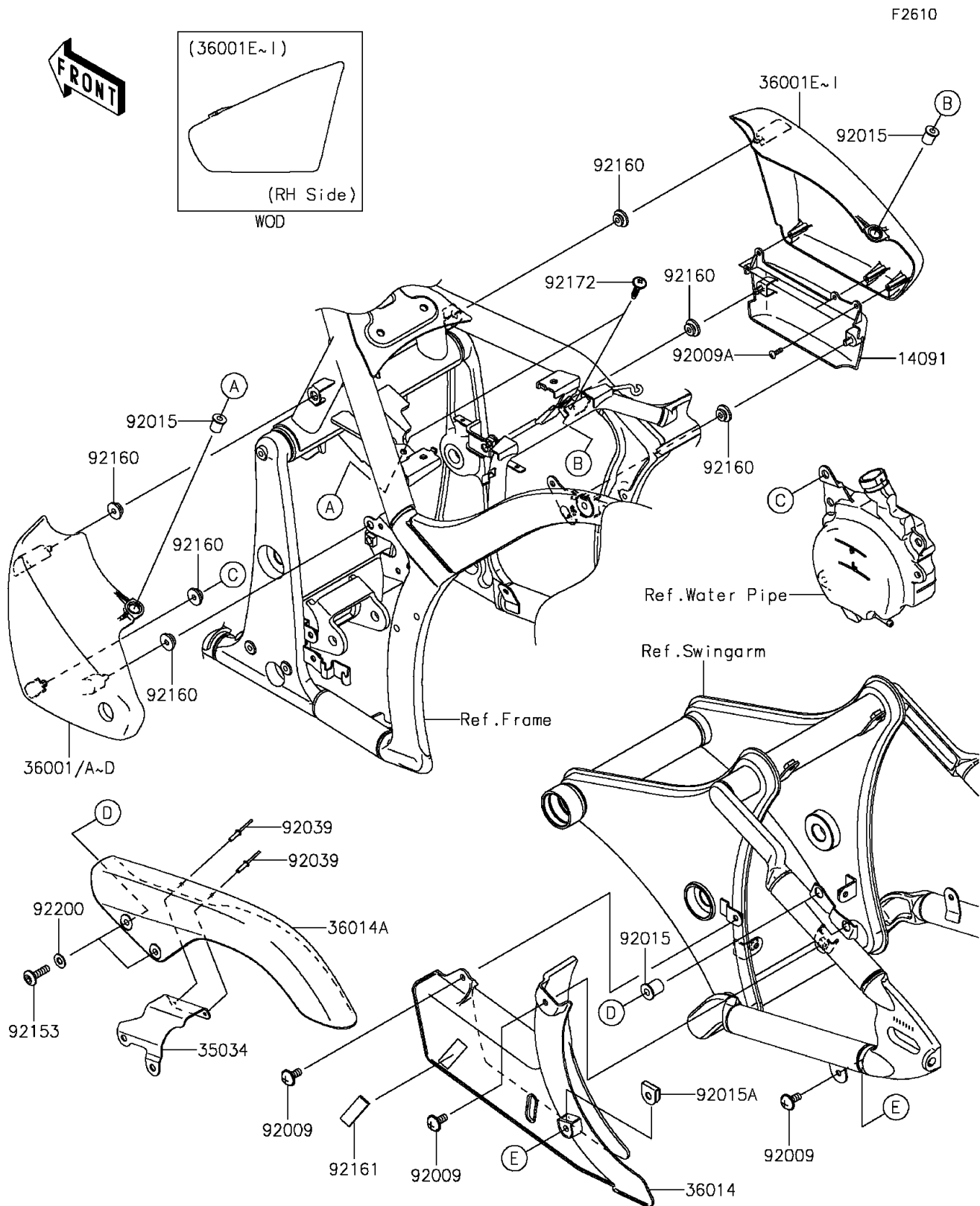

# 2011 VULCAN® 900 CLASSIC LT

## PARTS LIST

### Side Covers/Chain Cover

ITEM NAME	PART NUMBER	QUANTITY
-----------	-------------	----------

---