

2011 VULCAN® 900 CLASSIC LT

PARTS DIAGRAM

Brake Pedal/Torque Link

F2260

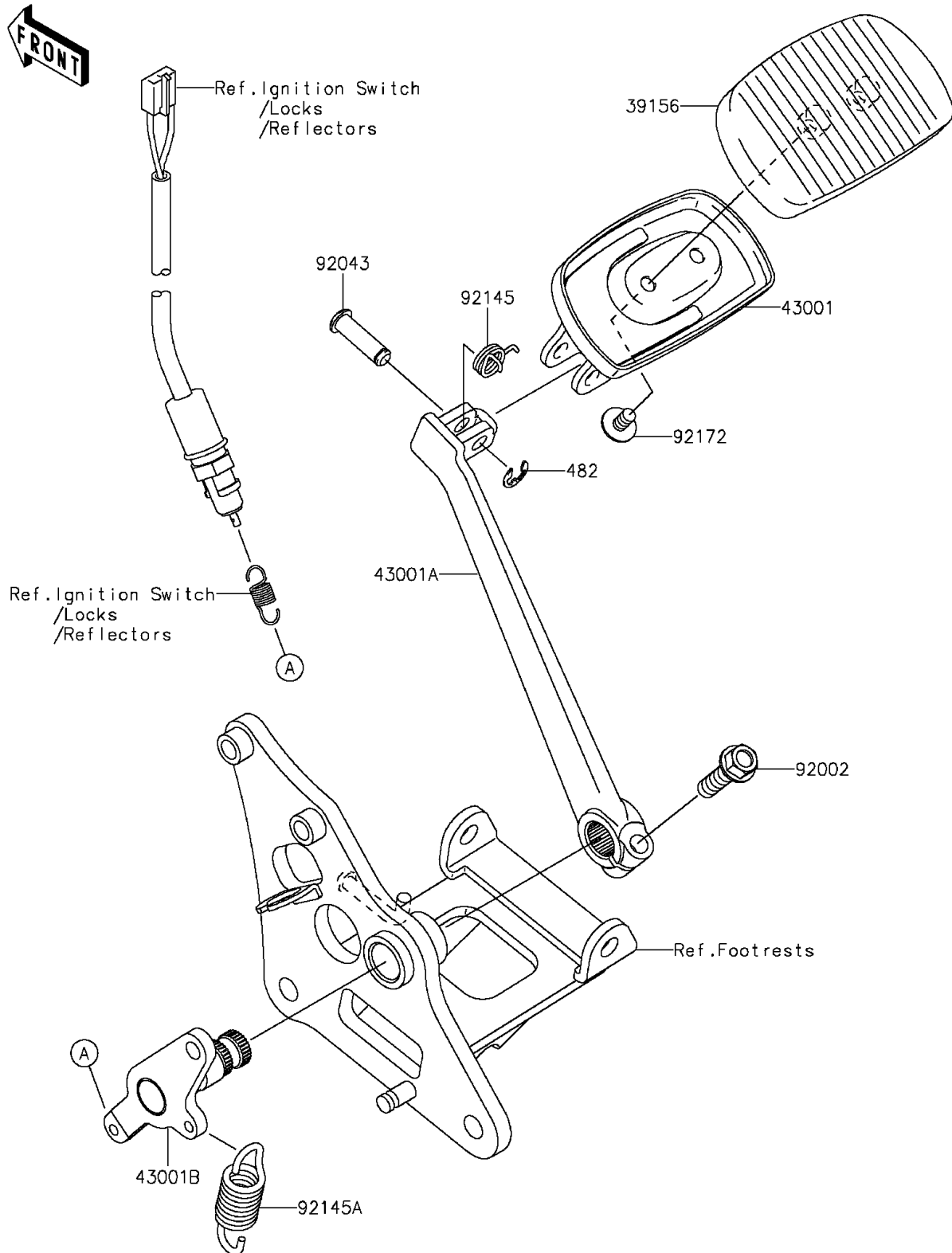

2011 VULCAN® 900 CLASSIC LT

PARTS LIST

Brake Pedal/Torque Link

ITEM NAME	PART NUMBER	QUANTITY
-----------	-------------	----------
