

2010 Vulcan® 900 Classic LT

PARTS DIAGRAM

Side Covers/Chain Cover

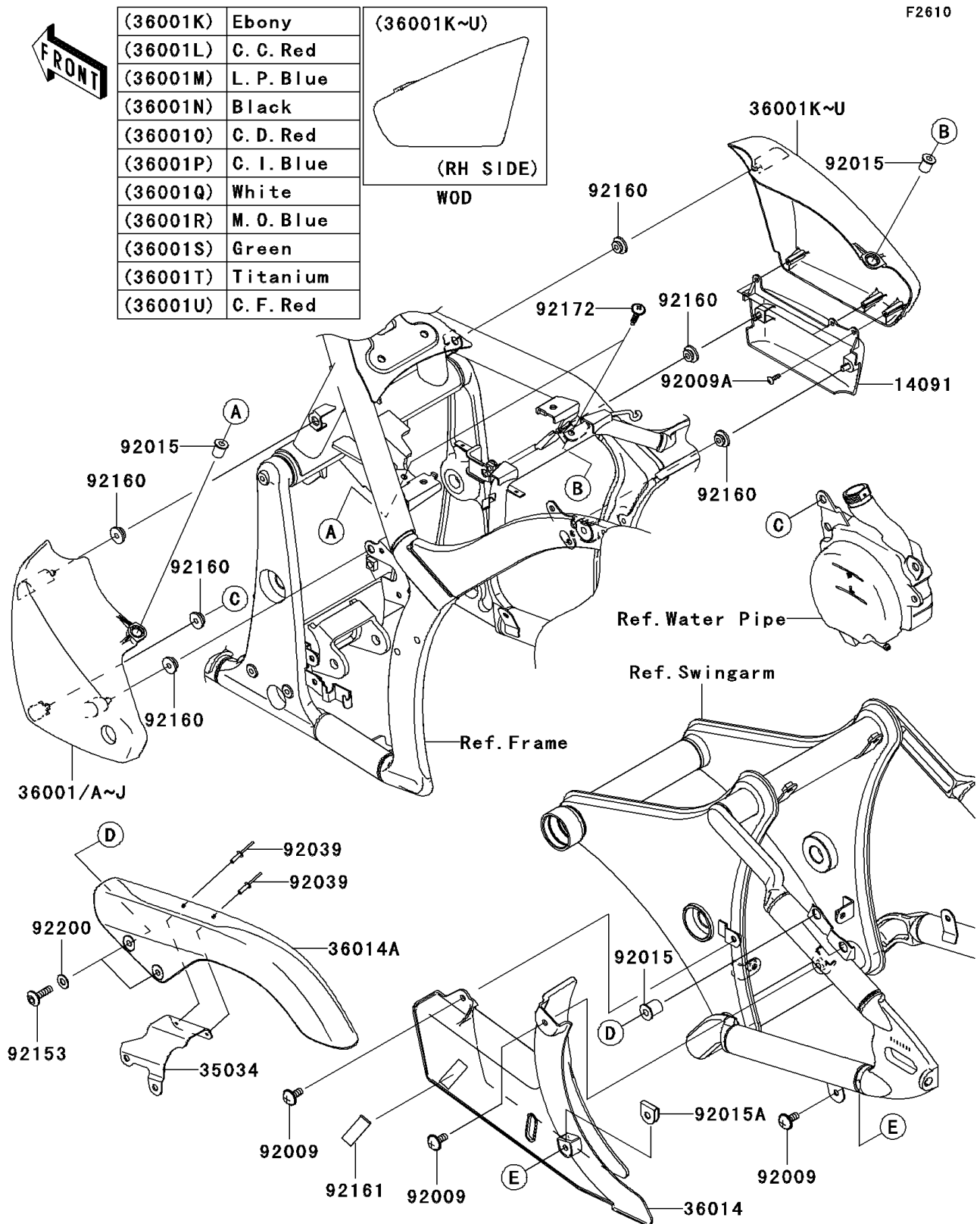

2010 Vulcan® 900 Classic LT

PARTS LIST

Side Covers/Chain Cover

ITEM NAME	PART NUMBER	QUANTITY
-----------	-------------	----------
