

# 2008 Vulcan® 900 Classic LT

## PARTS DIAGRAM

### Brake Pedal/Torque Link

F2260

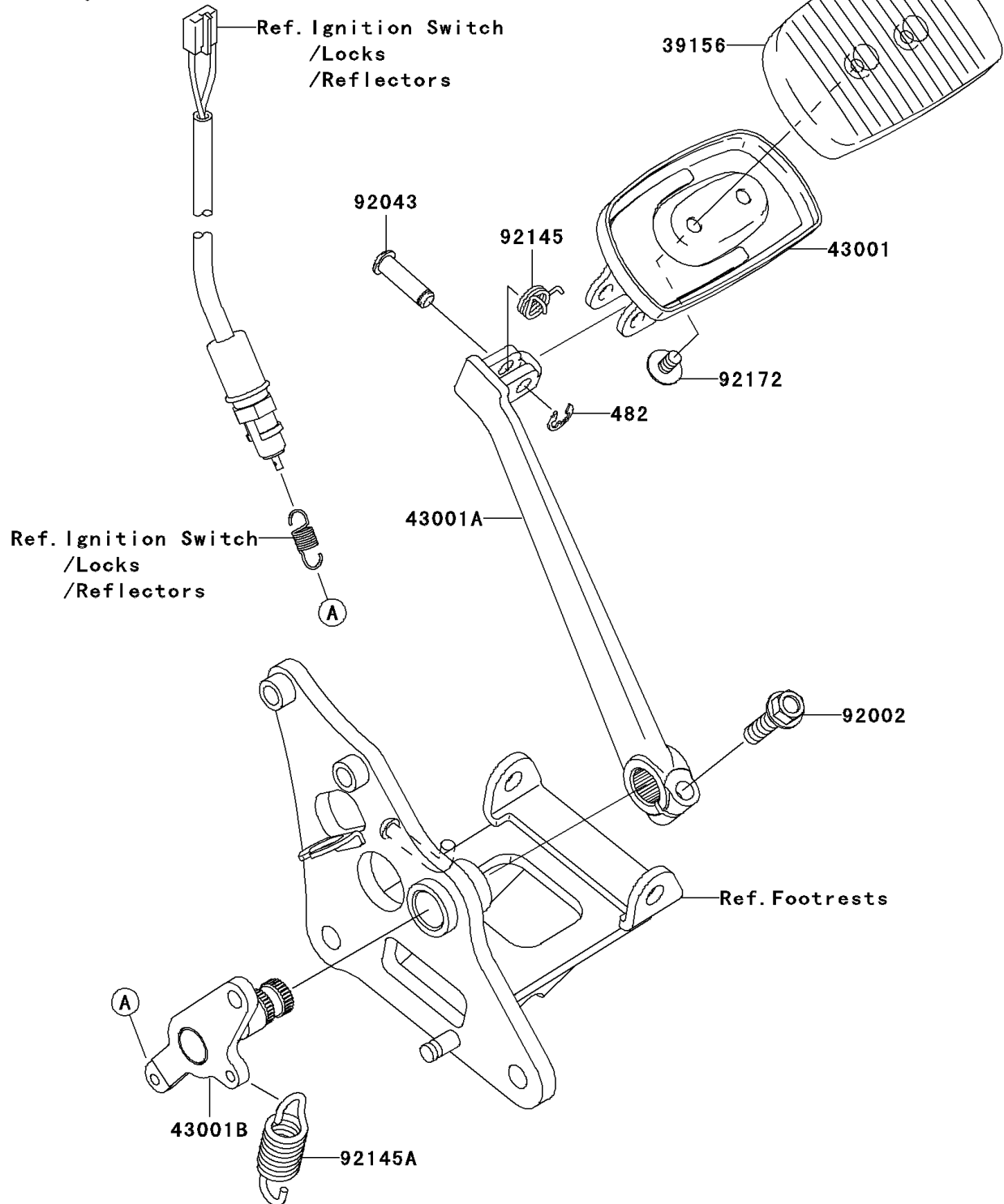

# 2008 Vulcan® 900 Classic LT

## PARTS LIST

### Brake Pedal/Torque Link

ITEM NAME	PART NUMBER	QUANTITY
-----------	-------------	----------

---