

# 2026 MULE SX™ 4x4

## PARTS DIAGRAM

### Cooling

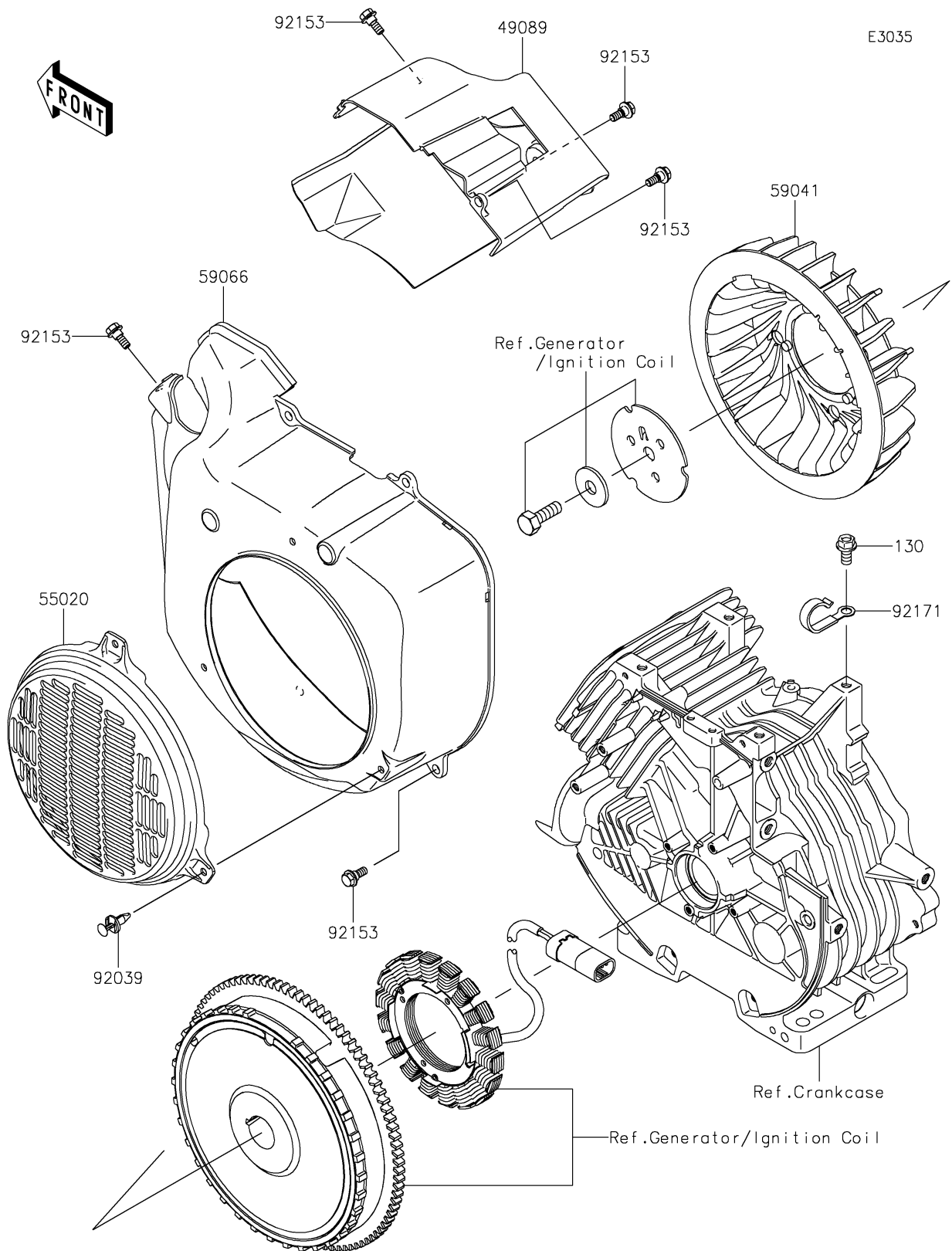

# 2026 MULE SX™ 4x4

## PARTS LIST

### Cooling

**ITEM NAME**

**PART NUMBER**

**QUANTITY**

---