

# 2026 MULE™ 4000

## PARTS DIAGRAM

### Valve(s)/Camshaft(s)

E1211

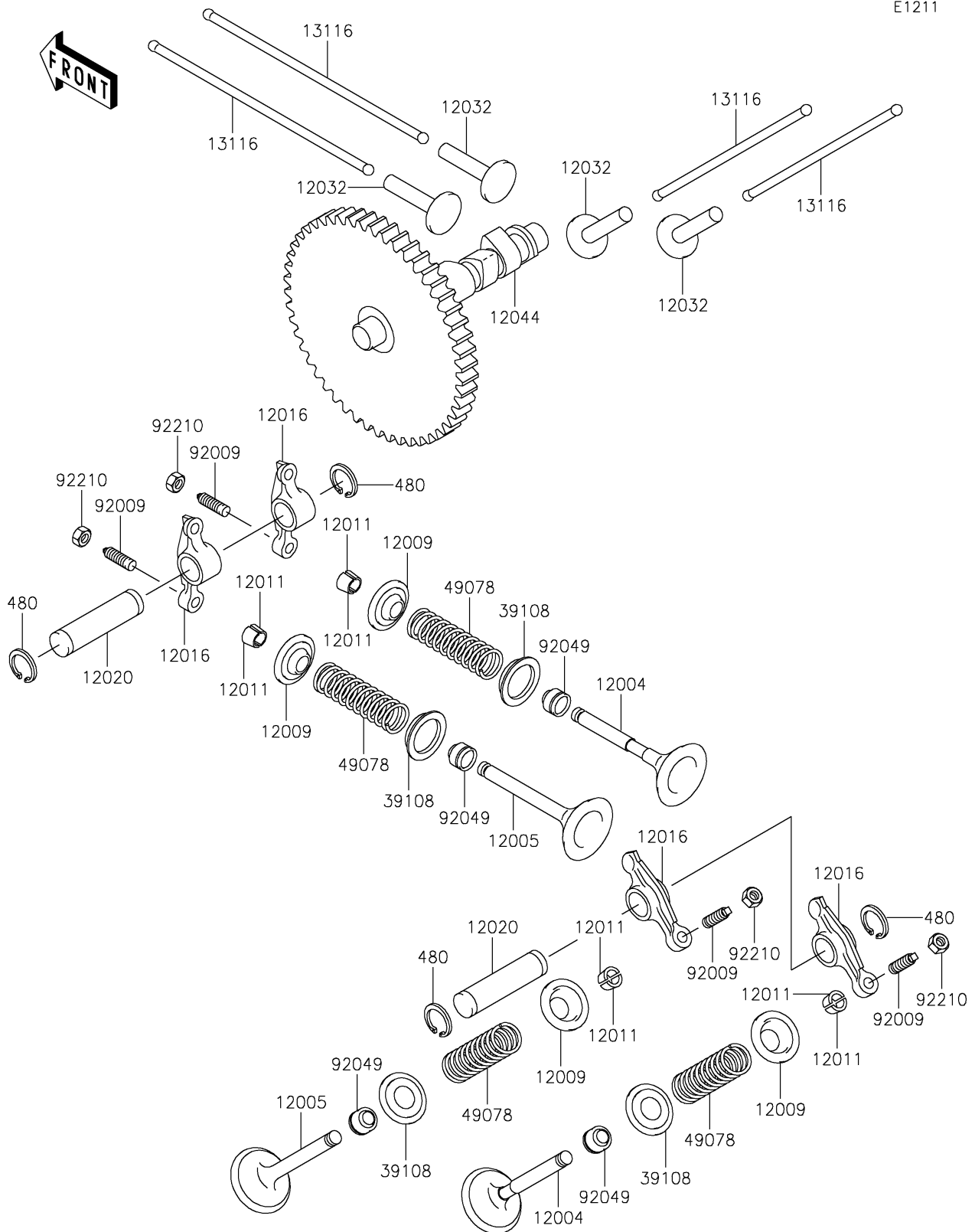

# 2026 MULE™ 4000

## PARTS LIST

Valve(s)/Camshaft(s)

**ITEM NAME**

**PART NUMBER**

**QUANTITY**

---