

2026 BRUTE FORCE® 750 EPS

PARTS DIAGRAM

Chassis Electrical Equipment

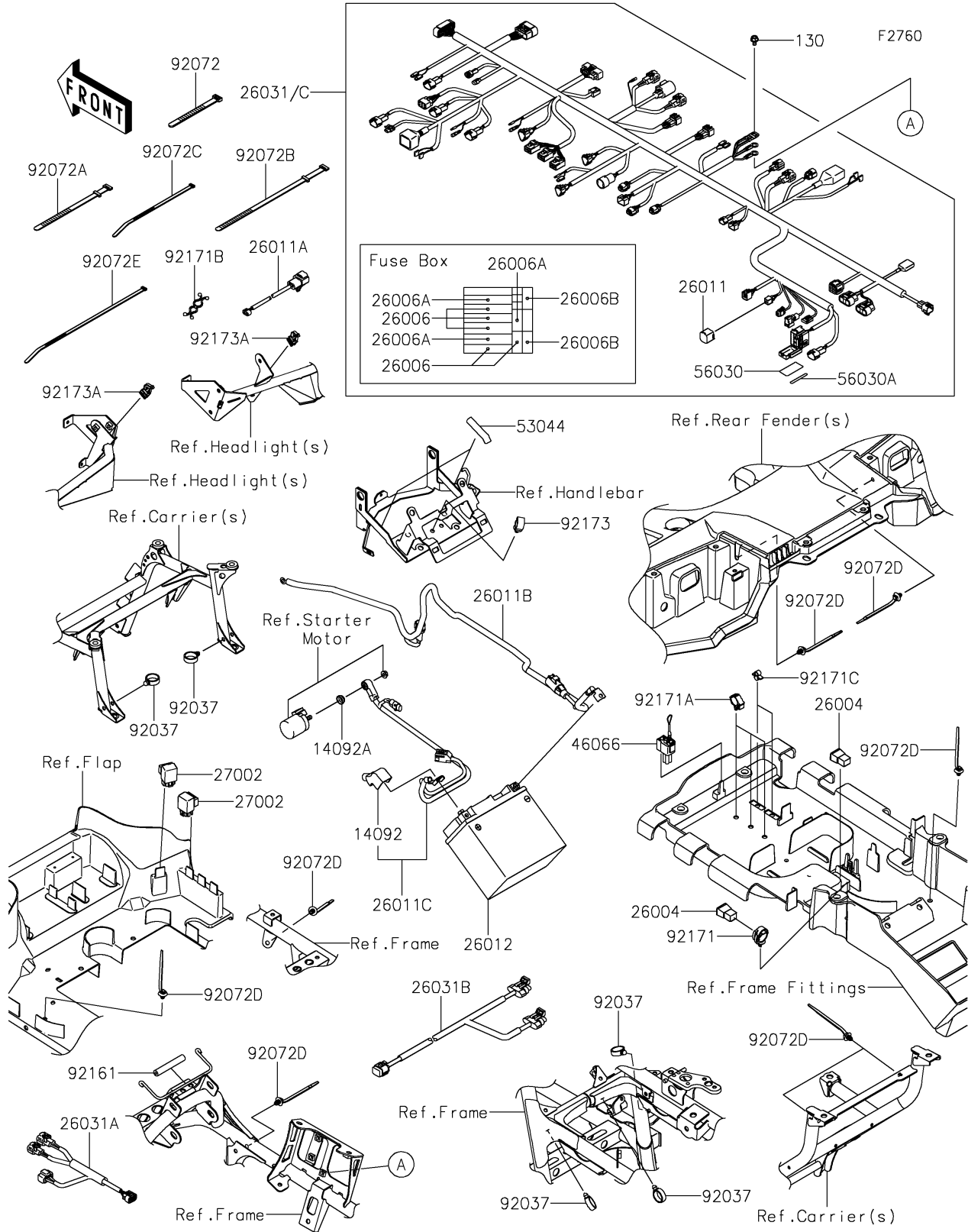

2026 BRUTE FORCE® 750 EPS

PARTS LIST

Chassis Electrical Equipment

ITEM NAME	PART NUMBER	QUANTITY
COVER (Ref # 14092)	14092-0767	1
COVER,MAGNETIC SW. (Ref # 14092A)	14092-0851	1
FUSE-ASSY,40A (Ref # 26004)	26004-0035	2
FUSE,MINI BLADE,15A,BLUE (Ref # 26006)	26006-0001	5
FUSE,MINI BLADE,10A,RED (Ref # 26006A)	26006-0009	3
FUSE,MINI BLADE,30A,GREEN (Ref # 26006B)	26006-1080	2
WIRE-LEAD,CAP (Ref # 26011)	26011-0271	1
WIRE-LEAD,EPS EXTENSION (Ref # 26011A)	26011-0312	1
WIRE-LEAD,BATTERY(-) (Ref # 26011B)	26011-0744	1
WIRE-LEAD,BATTERY(+) (Ref # 26011C)	26011-2463	1
BATTERY,MF,KMX14-BS,12V 12AH (Ref # 26012)	26012-1553	1
HARNESS,MAIN (Ref # 26031)	26031-4045	1
HARNESS,INJECTOR (Ref # 26031A)	26031-4136	1
HARNESS,TAIL LAMP (Ref # 26031B)	26031-4176	1
RELAY-ASSY (Ref # 27002)	27002-1062	2
CONNECTOR-ASSY,RESET (Ref # 46066)	46066-0001	1
TRIM,L=60 (Ref # 53044)	53044-0651	2
LABEL,FUSE BOX,10A&15A (Ref # 56030)	56030-0401	1
LABEL,FUSE BOX,30A (Ref # 56030A)	56030-0404	1
CLAMP,HOSE (Ref # 92037)	92037-1827	5
BAND,L=123 (Ref # 92072)	92072-030	11
BAND,L=186 (Ref # 92072A)	92072-056	4
BAND,L=278 (Ref # 92072B)	92072-1087	1
BAND,L=188 (Ref # 92072C)	92072-1239	7
BAND,OS170-FT7(BLACK) (Ref # 92072D)	92072-1414	8
BAND,L=292.1 (Ref # 92072E)	92072-3509	3
DAMPER,4.5X11X68 (Ref # 92161)	92161-0988	1
CLAMP,CLIP,DIA=20 (Ref # 92171)	92171-0068	1
CLAMP,BRAKE HOSE (Ref # 92171A)	92171-0316	3

2026 BRUTE FORCE® 750 EPS

PARTS LIST

Chassis Electrical Equipment

ITEM NAME	PART NUMBER	QUANTITY
CLAMP (Ref # 92171B)	92171-0476	1
CLAMP (Ref # 92171C)	92171-0477	2
CLAMP,12MM DIA. (Ref # 92173)	92173-0736	1
CLAMP,W/EDGE CLIP,DIA.6-45 (Ref # 92173A)	92173-1827	2
BOLT-FLANGED,6X10 (Ref # 130)	130BA0610	1