

2024 BRUTE FORCE® 750 EPS

PARTS DIAGRAM

Rear Fender(s)

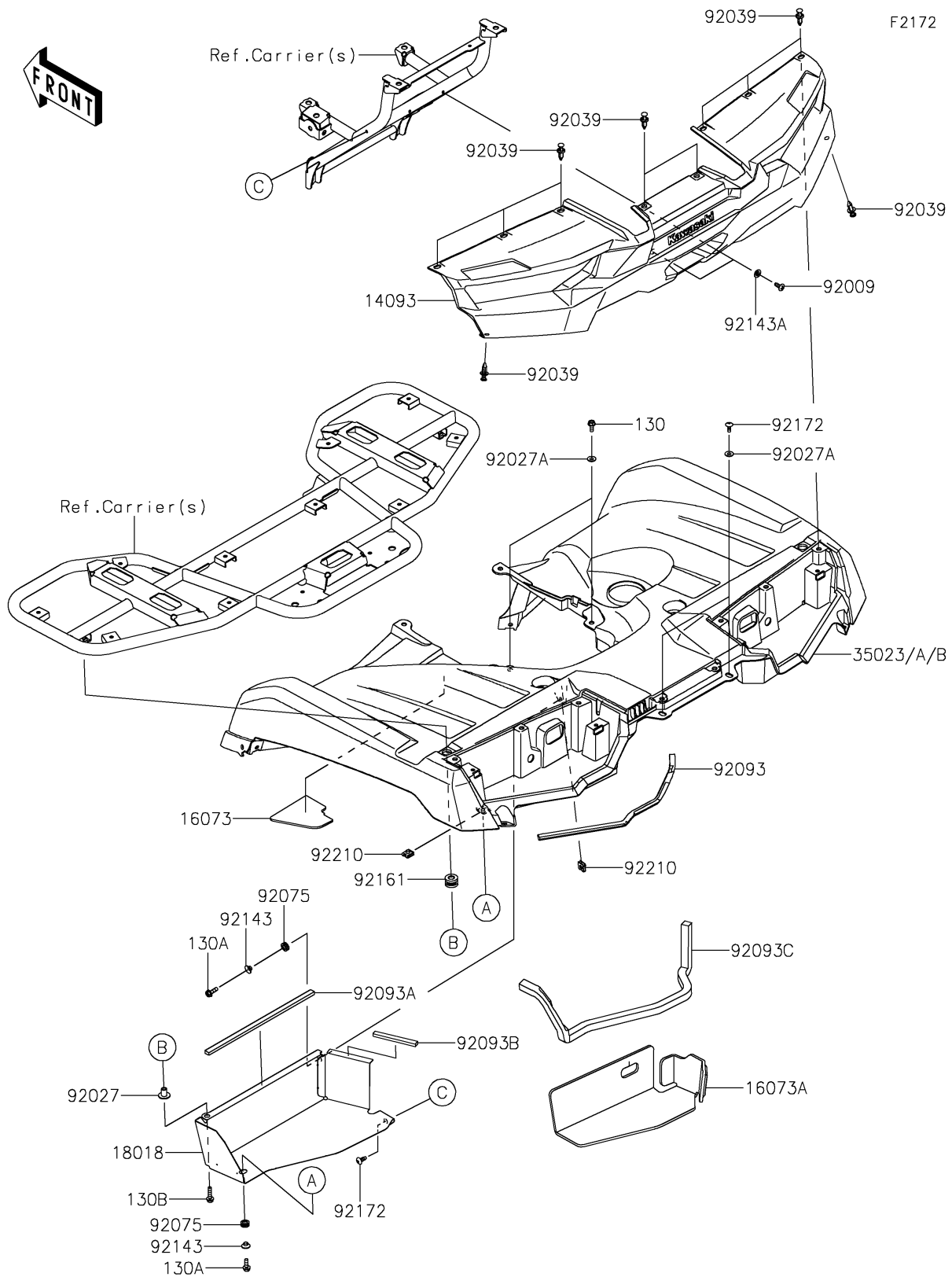

2024 BRUTE FORCE® 750 EPS

PARTS LIST

Rear Fender(s)

ITEM NAME	PART NUMBER	QUANTITY
COVER,RR (Ref # 14093)	14093-1509	1
INSULATOR (Ref # 16073)	16073-0926	1
INSULATOR,HEAT GUARD (Ref # 16073A)	16073-0951	1
PLATE-HEAT GUARD (Ref # 18018)	18018-0649	1
FENDER-REAR,G.BLUE (Ref # 35023A)	35023-0498-72W	1
SCREW,TAPPING,6X16 (Ref # 92009)	92009-1166	2
COLLAR,L=16.1 (Ref # 92027)	92027-1847	2
COLLAR (Ref # 92027A)	92027-4020	4
RIVET (Ref # 92039)	92039-0865	10
DAMPER (Ref # 92075)	92075-1947	2
SEAL,10X8X370 (Ref # 92093)	92093-0801	1
SEAL,10X6X285 (Ref # 92093A)	92093-0802	1
SEAL,10X6X90 (Ref # 92093B)	92093-0803	1
SEAL,15X15X615 (Ref # 92093C)	92093-0804	1
COLLAR (Ref # 92143)	92143-1057	2
COLLAR (Ref # 92143A)	92143-1087	2
DAMPER (Ref # 92161)	92161-0106	2
SCREW,TAPPING,6X16 (Ref # 92172)	92172-0739	3
NUT (Ref # 92210)	92210-0754	2
BOLT-FLANGED,6X16 (Ref # 130)	130BA0616	2
BOLT-FLANGED,6X18 (Ref # 130A)	130BA0618	2
BOLT-FLANGED,6X25 (Ref # 130B)	130BA0625	2