

# 2025 BRUTE FORCE® 750 EPS

## PARTS DIAGRAM

### Front Suspension

F2152

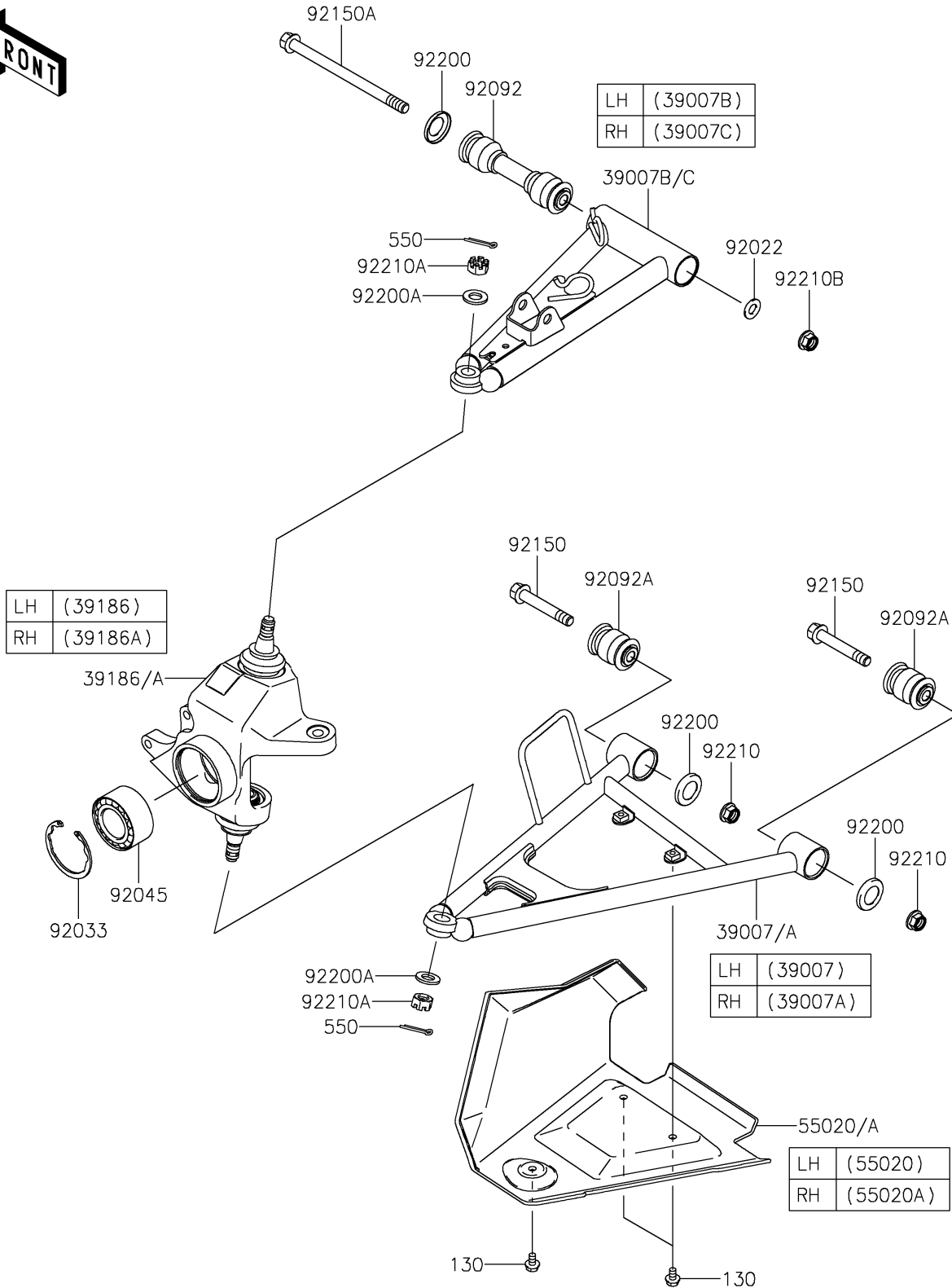

# 2025 BRUTE FORCE® 750 EPS

## PARTS LIST

### Front Suspension

ITEM NAME	PART NUMBER	QUANTITY
ARM-SUSP,FR,LWR,LH,BLACK (Ref # 39007)	39007-0176-10	1
ARM-SUSP,FR,LWR,RH,BLACK (Ref # 39007A)	39007-0177-10	1
ARM-SUSP,FR,UPP,LH,BLACK (Ref # 39007B)	39007-0341-10	1
ARM-SUSP,FR,UPP,RH,BLACK (Ref # 39007C)	39007-0342-10	1
KNUCKLE ASSY,FR,LH (Ref # 39186)	39186-0033	1
KNUCKLE ASSY,FR,RH (Ref # 39186A)	39186-0034	1
GUARD,FRONT ARM,LH,F.BLACK (Ref # 55020)	55020-0109-6Z	1
GUARD,FRONT ARM,RH,F.BLACK (Ref # 55020A)	55020-0110-6Z	1
WASHER,10.2X20X1.5 (Ref # 92022)	92022-3742	2
RING-SNAP,55MM (Ref # 92033)	92033-1274	2
BEARING-BALL,30BWD08ACA13 (Ref # 92045)	92045-0095	2
BUSHING-RUBBER (Ref # 92092)	92092-0025	2
BUSHING-RUBBER (Ref # 92092A)	92092-0026	4
BOLT,FLANGED,10X63 (Ref # 92150)	92150-1384	4
BOLT,FLANGED,10X150 (Ref # 92150A)	92150-1686	2
WASHER,19X31.8X4 (Ref # 92200)	92200-0582	6
WASHER,12.3X23X2.3 (Ref # 92200A)	92200-1004	4
NUT,LOCK,FLANGED,10MM (Ref # 92210)	92210-0276	4
NUT,CASTLE,12MM (Ref # 92210A)	92210-0395	4
NUT,LOCK,FLANGED,10MM (Ref # 92210B)	92210-1081	2
BOLT-FLANGED,6X10 (Ref # 130)	130BA0610	6
PIN-COTTER,3.0X25 (Ref # 550)	550AA3025	4