

2025 BRUTE FORCE® 750 EPS

PARTS DIAGRAM

Drive Shaft-Front

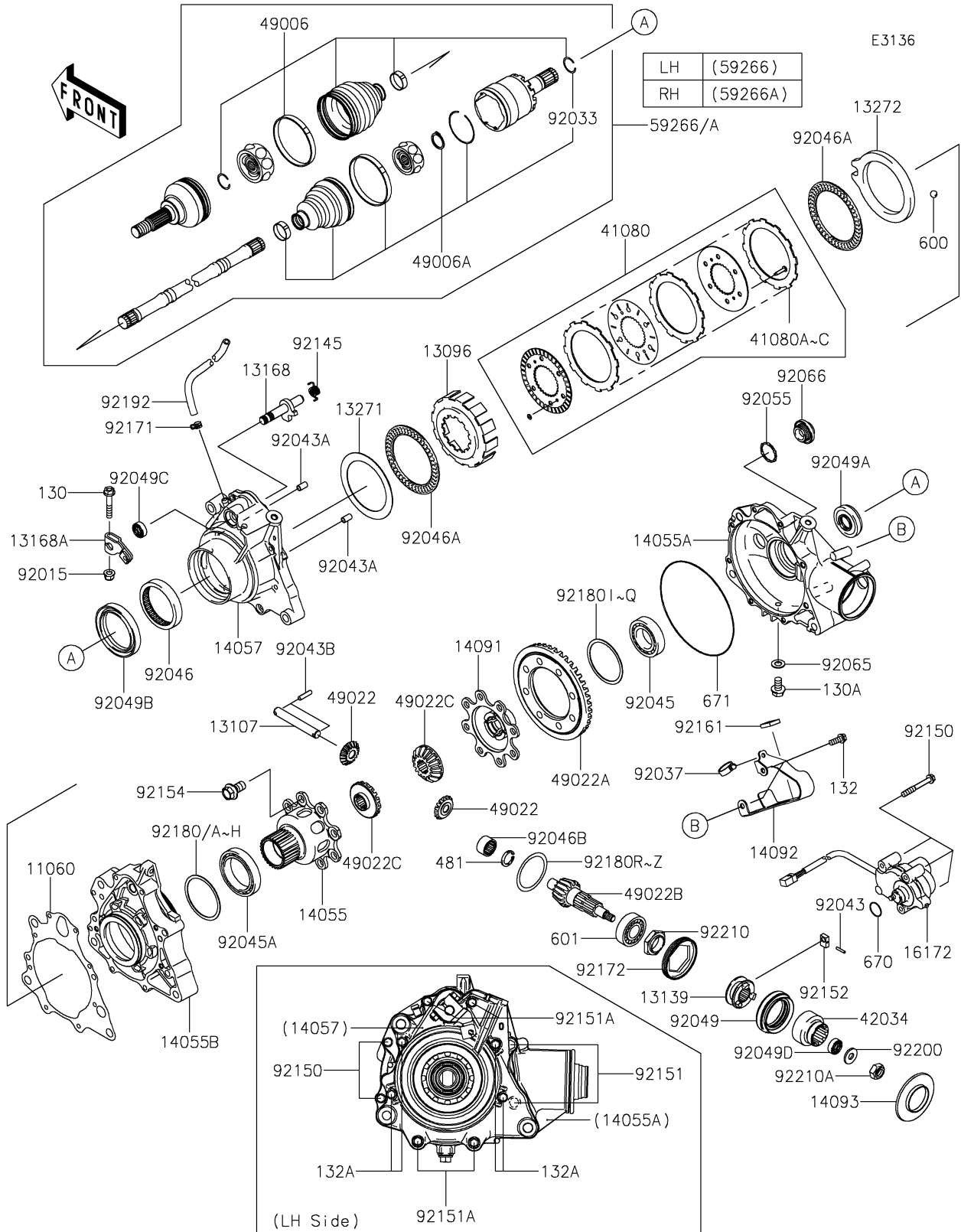

2025 BRUTE FORCE® 750 EPS

PARTS LIST

Drive Shaft-Front

ITEM NAME	PART NUMBER	QUANTITY
GASKET,DIFF CASE (Ref # 11060)	11060-1982	1
HOUSING-CLUTCH,DISC (Ref # 13096)	13096-1163	1
SHAFT,CROSS (Ref # 13107)	13107-0923	1
SHIFTER,DIFFERENTIAL (Ref # 13139)	13139-1097	1
LEVER,DIFF (Ref # 13168)	13168-1724	1
LEVER,DIFFERENTIAL (Ref # 13168A)	13168-1725	1
PLATE,DISC (Ref # 13271)	13271-1503	1
PLATE,CAM (Ref # 13272)	13272-0848	1
CASE-GEAR,BEVEL,LH (Ref # 14055)	14055-0601	1
CASE-GEAR (Ref # 14055A)	14055-0627	1
CASE-GEAR,CENTER (Ref # 14055B)	14055-0629	1
CASE-COMP-GEAR,DIFF,LH (Ref # 14057)	14057-0014	1
COVER,BEVEL,RH (Ref # 14091)	14091-1197	1
COVER (Ref # 14092)	14092-0202	1
COVER,COUPLING (Ref # 14093)	14093-0020	1
ACTUATOR (Ref # 16172)	16172-0039	1
DISC ASSY,DIFFERENTIAL LOCK (Ref # 41080)	41080-0609	1
DISC,T=1.20 (Ref # 41080A)	41080-1499	AR
DISC,T=1.80 (Ref # 41080B)	41080-1500	AR
DISC,T=2.40 (Ref # 41080C)	41080-1501	AR
COUPLING (Ref # 42034)	42034-0767	1
BOOT,UJ (Ref # 49006)	49006-0073	2
BOOT,DOJ (Ref # 49006A)	49006-0074	2
GEAR-BEVEL,10T (Ref # 49022)	49022-0575	2
GEAR-BEVEL,35T (Ref # 49022A)	49022-0610	1
GEAR-BEVEL,8T (Ref # 49022B)	49022-0611	1
GEAR-BEVEL,16T (Ref # 49022C)	49022-1178	2
JOINT-BALL (Ref # 59266)	59266-0024	1
JOINT-BALL (Ref # 59266A)	59266-0025	1

2025 BRUTE FORCE® 750 EPS

PARTS LIST

Drive Shaft-Front

ITEM NAME	PART NUMBER	QUANTITY
NUT,LOCK,FLANGED,6MM (Ref # 92015)	92015-1339	1
RING-SNAP (Ref # 92033)	92033-1298	2
CLAMP,HOSE (Ref # 92037)	92037-1827	1
PIN,2X10.5 (Ref # 92043)	92043-0083	1
PIN,6.2X8X14 (Ref # 92043A)	92043-1263	2
PIN (Ref # 92043B)	92043-1575	2
BEARING-BALL,60/32 (Ref # 92045)	92045-1393	1
BEARING-BALL,6910 (Ref # 92045A)	92045-1394	1
BEARING-NEEDLE (Ref # 92046)	92046-0028	1
BEARING-NEEDLE,AK1116 (Ref # 92046A)	92046-1286	2
BEARING-NEEDLE,AJ501515W (Ref # 92046B)	92046-1297	1
SEAL-OIL,TC9Y 48X65X9X15.3 (Ref # 92049)	92049-0754	1
SEAL-OIL,SDD7 22X48X7HS (Ref # 92049A)	92049-1534	1
SEAL-OIL,HTCY 62X81X10.5 (Ref # 92049B)	92049-1536	1
SEAL-OIL,TC 12X22X7 (Ref # 92049C)	92049-1550	1
SEAL-OIL,KB 13X19X13 (Ref # 92049D)	92049-1572	1
RING-O (Ref # 92055)	92055-0122	1
GASKET,8.5X16X1 (Ref # 92065)	92065-023	1
PLUG (Ref # 92066)	92066-1303	1
SPRING,DIFF RETURN (Ref # 92145)	92145-1344	1
BOLT,6X45 (Ref # 92150)	92150-1884	5
BOLT,8X50 (Ref # 92151)	92151-1794	2
BOLT,6X60 (Ref # 92151A)	92151-1795	4
COLLAR (Ref # 92152)	92152-1349	1
BOLT,10X19.5 (Ref # 92154)	92154-4340	8
DAMPER,20X20X5 (Ref # 92161)	92161-1387	1
CLAMP (Ref # 92171)	92171-0515	1
SCREW,SET,64X10 (Ref # 92172)	92172-0719	1
SHIM,62X71X0.15 (Ref # 92180)	92180-1390	AR

2025 BRUTE FORCE® 750 EPS

PARTS LIST

Drive Shaft-Front

ITEM NAME	PART NUMBER	QUANTITY
SHIM,62X71X0.20 (Ref # 92180A)	92180-1391	AR
SHIM,62X71X0.50 (Ref # 92180B)	92180-1392	AR
SHIM,62X71X0.70 (Ref # 92180C)	92180-1393	AR
SHIM,62X71X0.80 (Ref # 92180D)	92180-1394	AR
SHIM,62X71X0.90 (Ref # 92180E)	92180-1395	AR
SHIM,62X71X1.00 (Ref # 92180F)	92180-1396	AR
SHIM,62X71X1.10 (Ref # 92180G)	92180-1397	AR
SHIM,62X71X1.20 (Ref # 92180H)	92180-1398	AR
SHIM,32X42X0.15 (Ref # 92180I)	92180-1399	AR
SHIM,32X42X0.20 (Ref # 92180J)	92180-1400	AR
SHIM,32X42X0.50 (Ref # 92180K)	92180-1401	AR
SHIM,32X42X0.70 (Ref # 92180L)	92180-1402	AR
SHIM,32X42X0.80 (Ref # 92180M)	92180-1403	AR
SHIM,32X42X0.90 (Ref # 92180N)	92180-1404	AR
SHIM,32X42X1.00 (Ref # 92180O)	92180-1405	AR
SHIM,32X42X1.10 (Ref # 92180P)	92180-1406	AR
SHIM,32X42X1.20 (Ref # 92180Q)	92180-1407	AR
SHIM,50X61X0.15 (Ref # 92180R)	92180-1408	AR
SHIM,50X61X0.20 (Ref # 92180S)	92180-1409	AR
SHIM,50X61X0.50 (Ref # 92180T)	92180-1410	AR
SHIM,50X61X0.70 (Ref # 92180U)	92180-1411	AR
SHIM,50X61X0.80 (Ref # 92180V)	92180-1412	AR
SHIM,50X61X0.90 (Ref # 92180W)	92180-1413	AR
SHIM,50X61X1.00 (Ref # 92180X)	92180-1414	AR
SHIM,50X61X1.10 (Ref # 92180Y)	92180-1415	AR
SHIM,50X61X1.20 (Ref # 92180Z)	92180-1416	AR
TUBE,7X12X760 (Ref # 92192)	92192-0716	1
WASHER,10X24X2.5 (Ref # 92200)	92200-1635	1
NUT,25MM (Ref # 92210)	92210-1225	1

2025 BRUTE FORCE® 750 EPS

PARTS LIST

Drive Shaft-Front

ITEM NAME	PART NUMBER	QUANTITY
NUT,LOCK,10MM (Ref # 92210A)	92210-1351	1
BOLT-FLANGED,6X35 (Ref # 130)	130BA0635	1
BOLT-FLANGED,8X14 (Ref # 130A)	130BA0814	1
BOLT-FLANGED-SMALL,6X16 (Ref # 132)	132BA0616	2
BOLT-FLANGED-SMALL,6X30 (Ref # 132A)	132BA0630	4
CIRCLIP-TYPE-C,25MM (Ref # 481)	481J2500	1
BALL-STEEL,11/32 (Ref # 600)	600A1100	6
BEARING-BALL,#6305 (Ref # 601)	601A6305	1
O RING (Ref # 670)	670D3022	1
O RING (Ref # 671)	671D25145	1