

# 2026 BRUTE FORCE® 750 EPS

## PARTS DIAGRAM

### Transmission

E1361

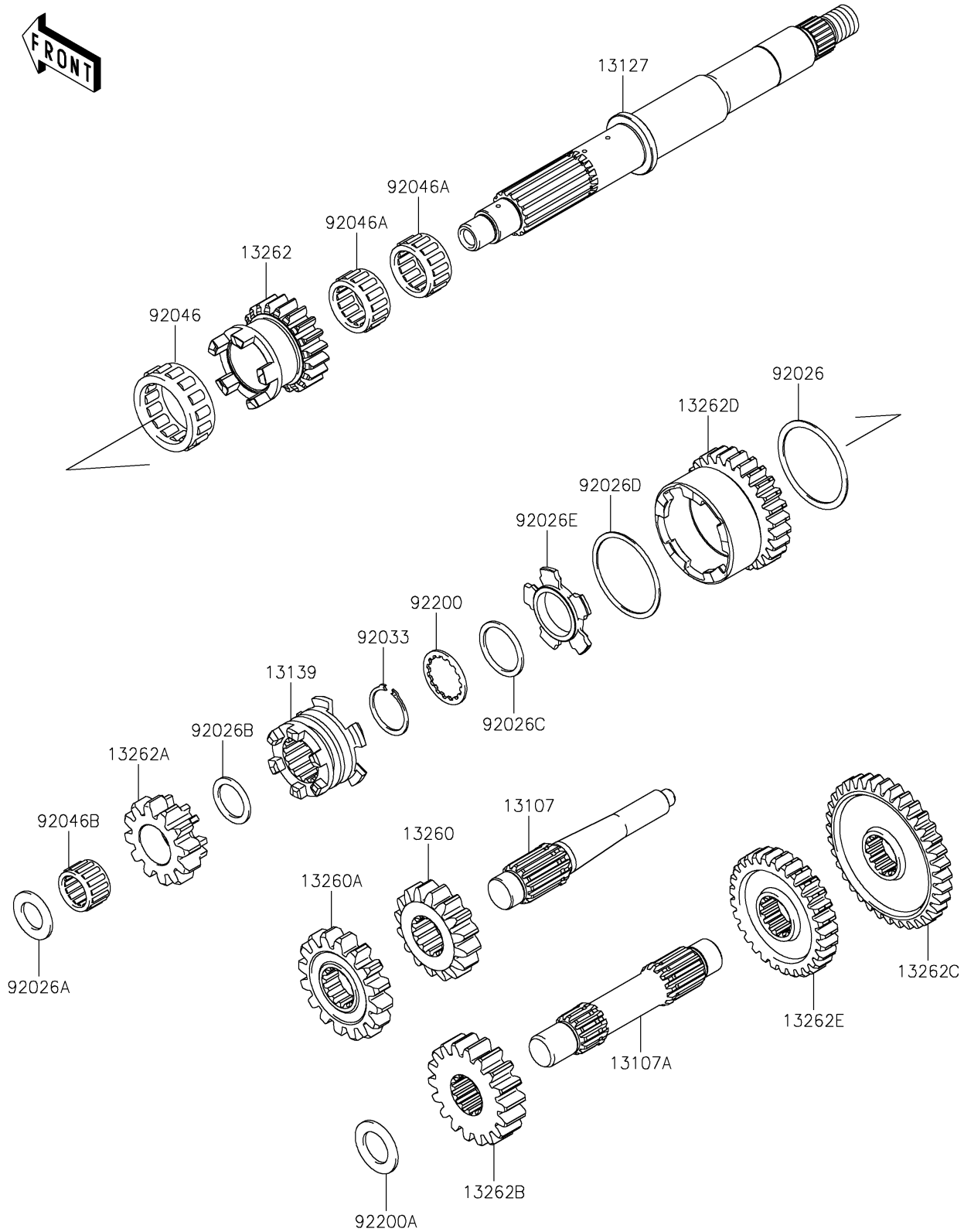

# 2026 BRUTE FORCE® 750 EPS

## PARTS LIST

### Transmission



**ITEM NAME**

**PART NUMBER**

**QUANTITY**

---