

# 2026 BRUTE FORCE® 750 EPS

## PARTS DIAGRAM

### Crankshaft

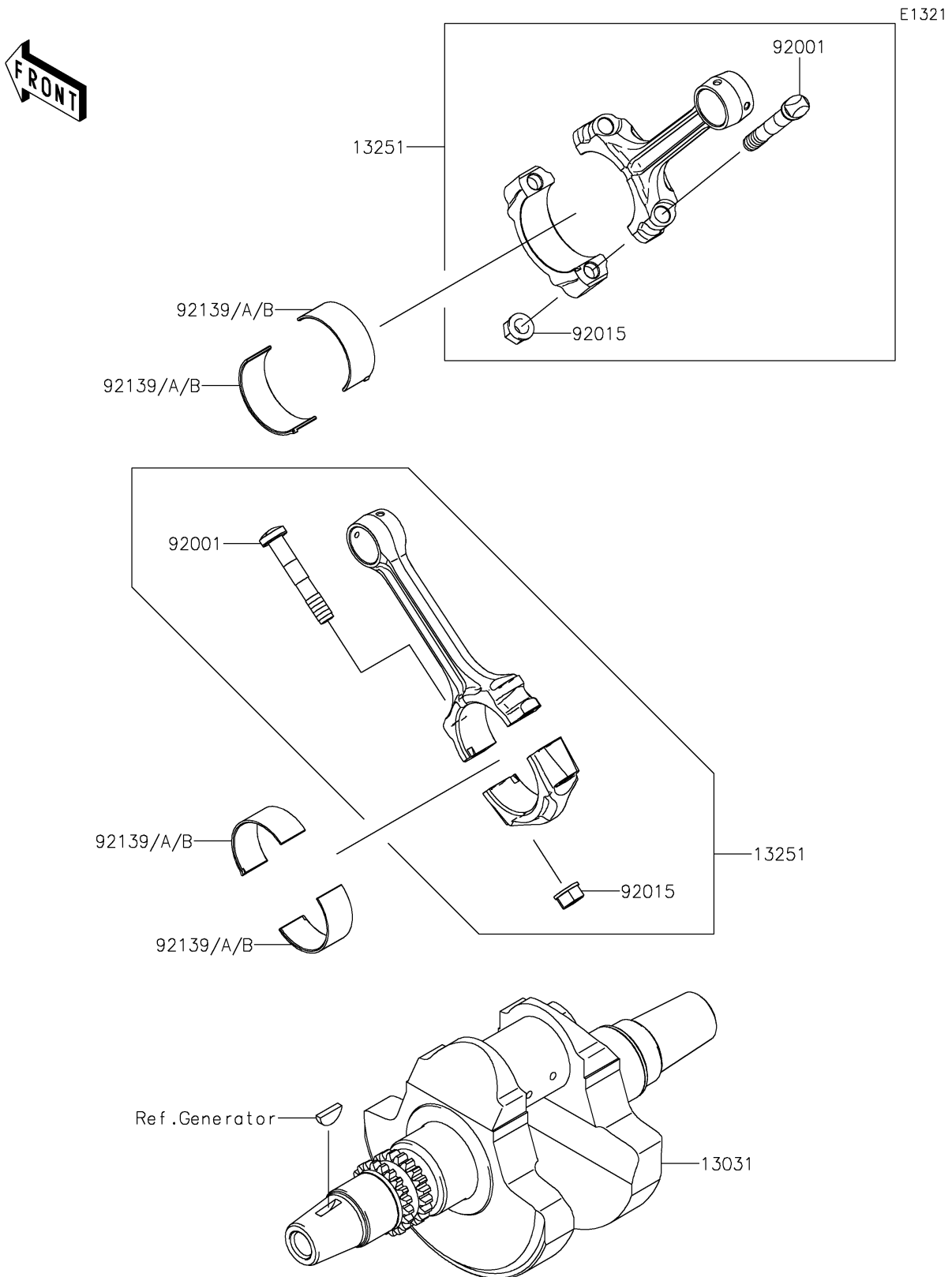

# 2026 BRUTE FORCE® 750 EPS

## PARTS LIST

### Crankshaft

ITEM NAME	PART NUMBER	QUANTITY
CRANKSHAFT-COMP (Ref # 13031)	13031-0938	1
ROD-ASSY-CONNECTING (Ref # 13251)	13251-0709	2
BOLT,CONNECTING ROD (Ref # 92001)	92001-1980	4
NUT,FLANGED,8MM (Ref # 92015)	92015-1311	4
BUSHING,CONNECTING ROD,GREEN (Ref # 92139)	92139-0764	AR
BUSHING,CONNECTING ROD,YELLOW (Ref # 92139A)	92139-0765	4
BUSHING,CONNECTING ROD,BROWN (Ref # 92139B)	92139-0766	AR