

2024 Vulcan S CAFÉ

PARTS DIAGRAM Front Master Cylinder

F2291

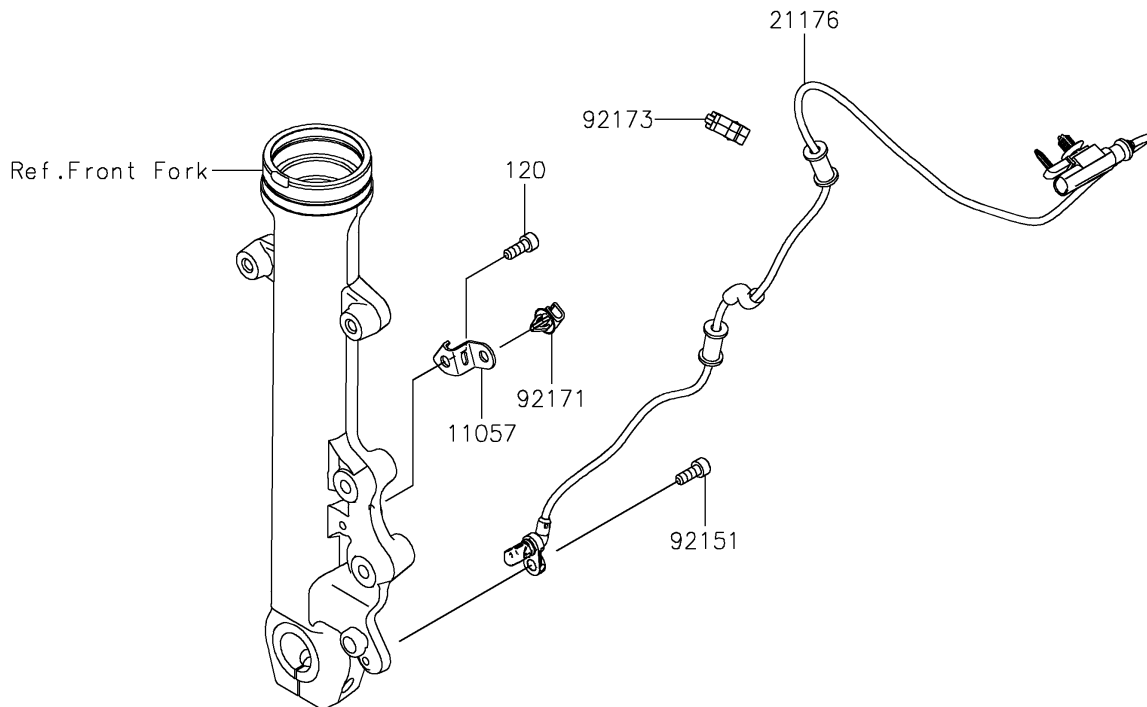
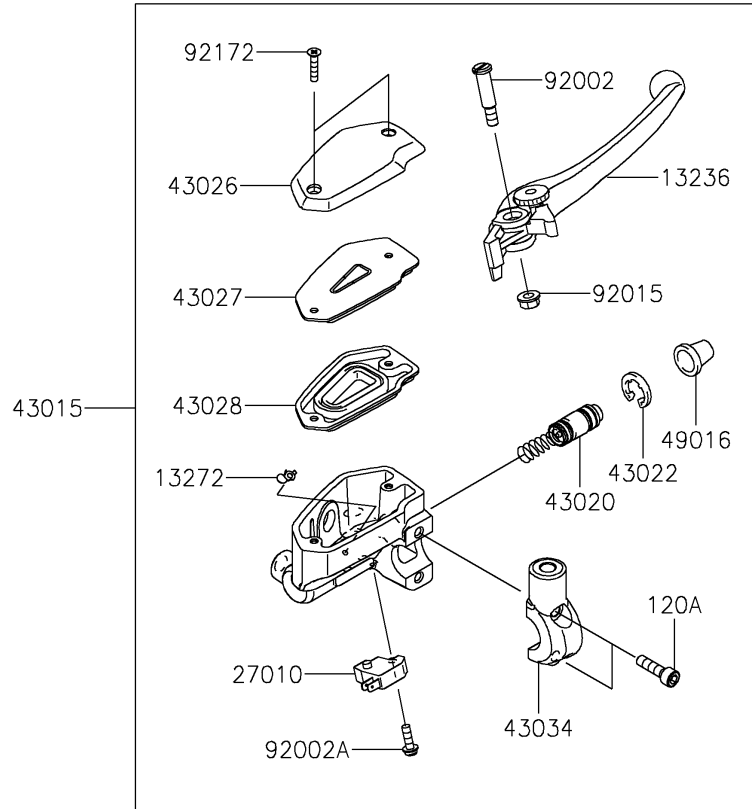

2024 Vulcan S CAFÉ

PARTS LIST

Front Master Cylinder

ITEM NAME	PART NUMBER	QUANTITY
BRACKET,FORK OUTER TUBE,LWR (Ref # 11057)	11057-0628	1
LEVER-COMP,FRONT BRAKE (Ref # 13236)	13236-0140	1
PLATE (Ref # 13272)	13272-0573	1
SENSOR,FR WHEEL SPEED (Ref # 21176)	21176-0953	1
SWITCH,BRAKE (Ref # 27010)	27010-0762	1
CYLINDER-ASSY-MASTER,FR (Ref # 43015)	43015-0606	1
PISTON-COMP-BRAKE (Ref # 43020)	43020-1095	1
STOPPER-BRAKE,PISTON (Ref # 43022)	43022-1010	1
CAP-BRAKE (Ref # 43026)	43026-0019	1
PLATE-DIAPHRAGM (Ref # 43027)	43027-0008	1
DIAPHRAGM (Ref # 43028)	43028-0015	1
HOLDER-BRAKE,MASTER CYLINDER (Ref # 43034)	43034-0049	1
COVER-SEAL,MASTER CYLINDER (Ref # 49016)	49016-1044	1
BOLT,LEVER SET,BLACK (Ref # 92002)	92002-1322	1
BOLT,SCREW,4X12 (Ref # 92002A)	92002-1323	1
NUT,FLANGED,6MM (Ref # 92015)	92015-1528	1
BOLT (Ref # 92151)	92151-1166	1
CLAMP (Ref # 92171)	92171-0640	1
SCREW,4X20 (Ref # 92172)	92172-0320	2
CLAMP,HOSE&SENSOR LINE (Ref # 92173)	92173-1613	1
BOLT-SOCKET,6X16 (Ref # 120)	120CA0616	1
BOLT-SOCKET,6X22 (Ref # 120A)	120CB0622	2