

2026 VULCAN® S CAFE ABS

PARTS DIAGRAM

Footrests

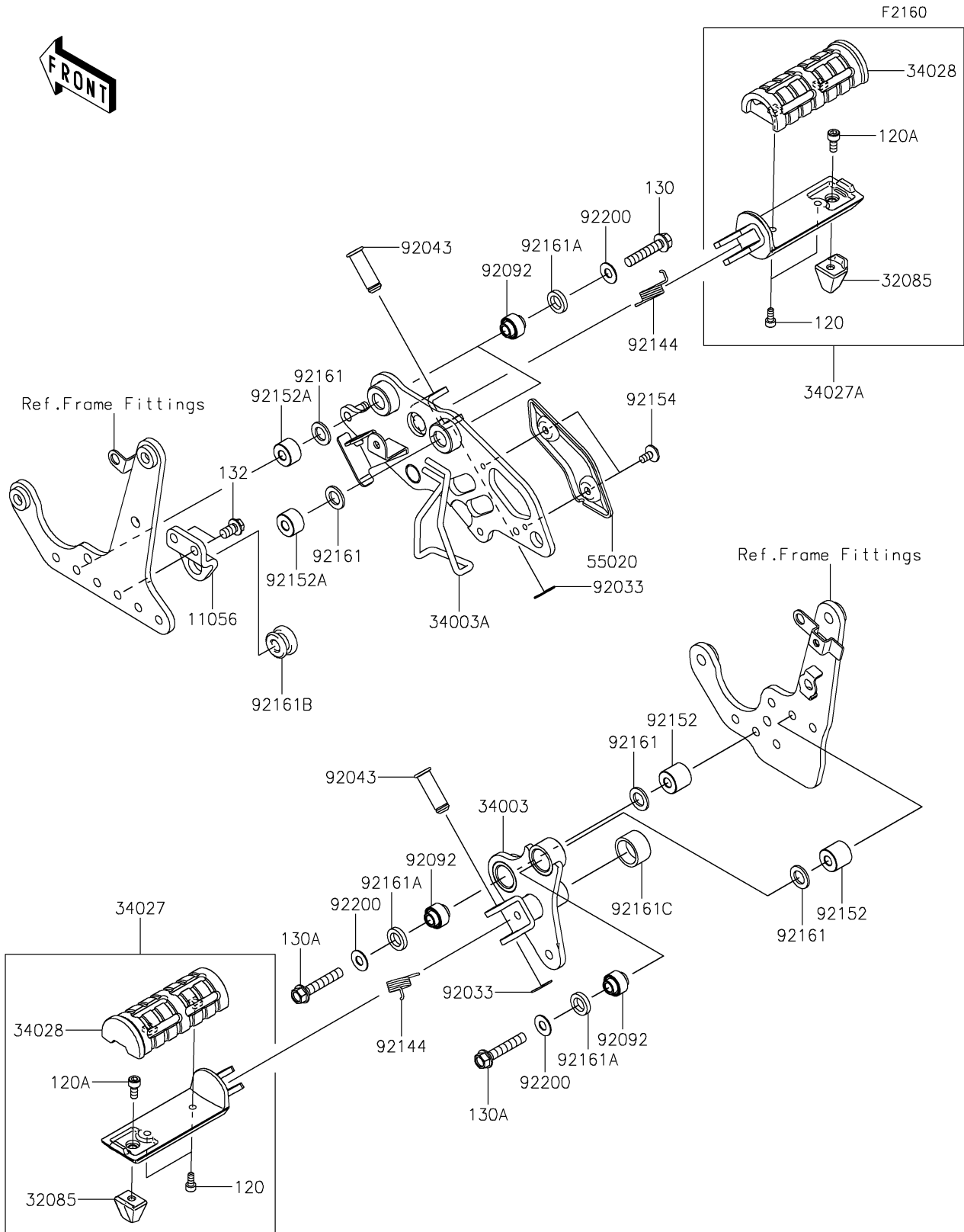

2026 VULCAN[®] S CAFE ABS

PARTS LIST

Footrests

ITEM NAME

PART NUMBER

QUANTITY
