

# 2026 KLX230R S

## PARTS DIAGRAM

### Crankcase

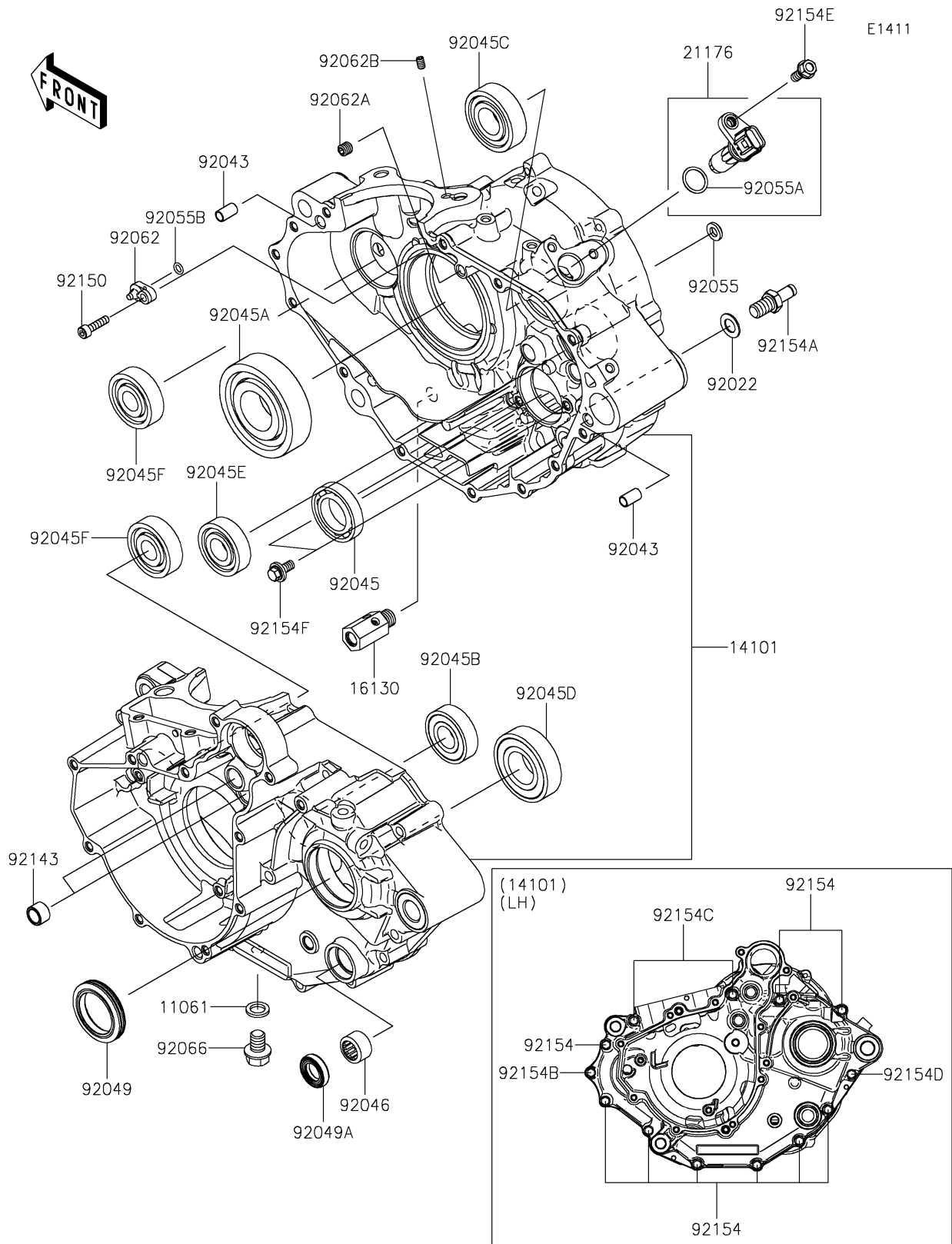

# 2026 KLX230R S

## PARTS LIST

### Crankcase

ITEM NAME	PART NUMBER	QUANTITY
GASKET,10.5X16X2 (Ref # 11061)	11061-0222	1
SET-CRANKCASE (Ref # 14101)	14101-0052	1
VALVE-ASSY-RELIEF (Ref # 16130)	16130-0002	1
SENSOR,SPEED (Ref # 21176)	21176-0894	1
WASHER,10.2X18X1.0,SK5 (Ref # 92022)	92022-1415	1
PIN,6.2X8X14 (Ref # 92043)	92043-1741	2
BEARING-BALL,25X42X9 (Ref # 92045)	92045-0881	1
BEARING-BALL,6306CM (Ref # 92045A)	92045-0907	1
BEARING-BALL,6203NSE9C3 (Ref # 92045B)	92045-0908	1
BEARING-BALL,6204C3 (Ref # 92045C)	92045-0909	1
BEARING-BALL,6205NSE9C3 (Ref # 92045D)	92045-0910	1
BEARING-BALL,6203C3 (Ref # 92045E)	92045-0911	1
BEARING-BALL,6302CS13 (Ref # 92045F)	92045-0912	2
BEARING-NEEDLE,HK1412FM (Ref # 92046)	92046-0043	1
SEAL-OIL,32X45X7.5 (Ref # 92049)	92049-0825	1
SEAL-OIL,TC14245 (Ref # 92049A)	92049-1520	1
RING-O,OD=13 (Ref # 92055)	92055-074	1
RING-O (Ref # 92055A)	92055-0958	1
RING-O,5.5X1.5 (Ref # 92055B)	92055-1339	1
NOZZLE (Ref # 92062)	92062-0050	1
NOZZLE,8X8 (Ref # 92062A)	92062-0567	1
NOZZLE,6X8,SILVER (Ref # 92062B)	92062-1081	1
PLUG,DRAIN (Ref # 92066)	92066-0978	1
COLLAR (Ref # 92143)	92143-1263	2
BOLT,SOCKET,5X20 (Ref # 92150)	92150-1019	1
BOLT,6X50 (Ref # 92154)	92154-1168	9
BOLT,RETURN SPRING (Ref # 92154A)	92154-1306	1
BOLT,FLANGED,6X30 (Ref # 92154B)	92154-2758	1
BOLT,FLANGED,6X70 (Ref # 92154C)	92154-2764	2

# 2026 KLX230R S

## PARTS LIST

### Crankcase

ITEM NAME	PART NUMBER	QUANTITY
BOLT,FLANGED,6X65 (Ref # 92154D)	92154-2766	1
BOLT,FLANGED,6X16 (Ref # 92154E)	92154-2895	1
BOLT,W/WASHER,6X14 (Ref # 92154F)	92154-7475	2