

2024 MULE PRO-FXT 1000 LE Ranch Edition

PARTS DIAGRAM

Shock Absorber(s)

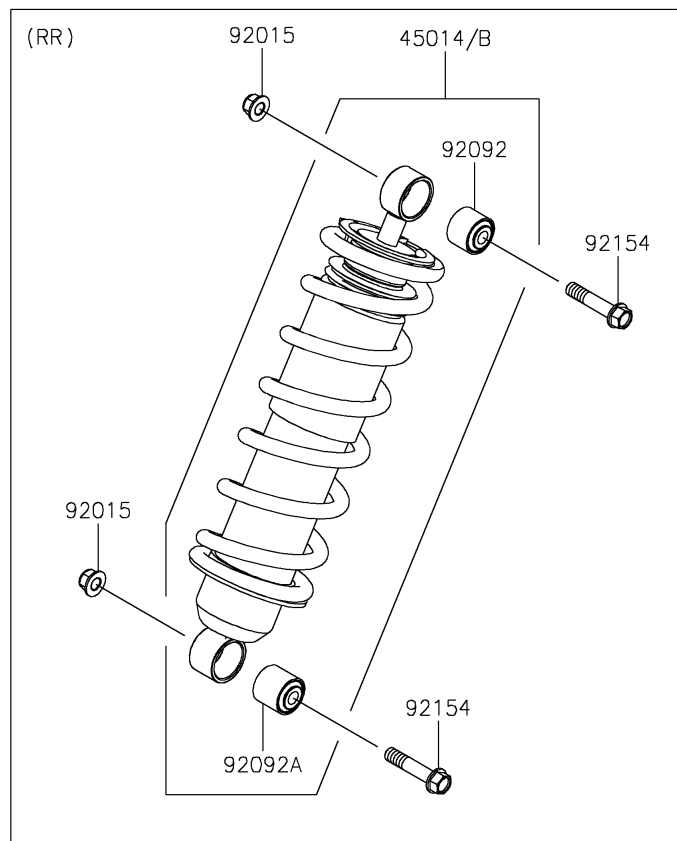
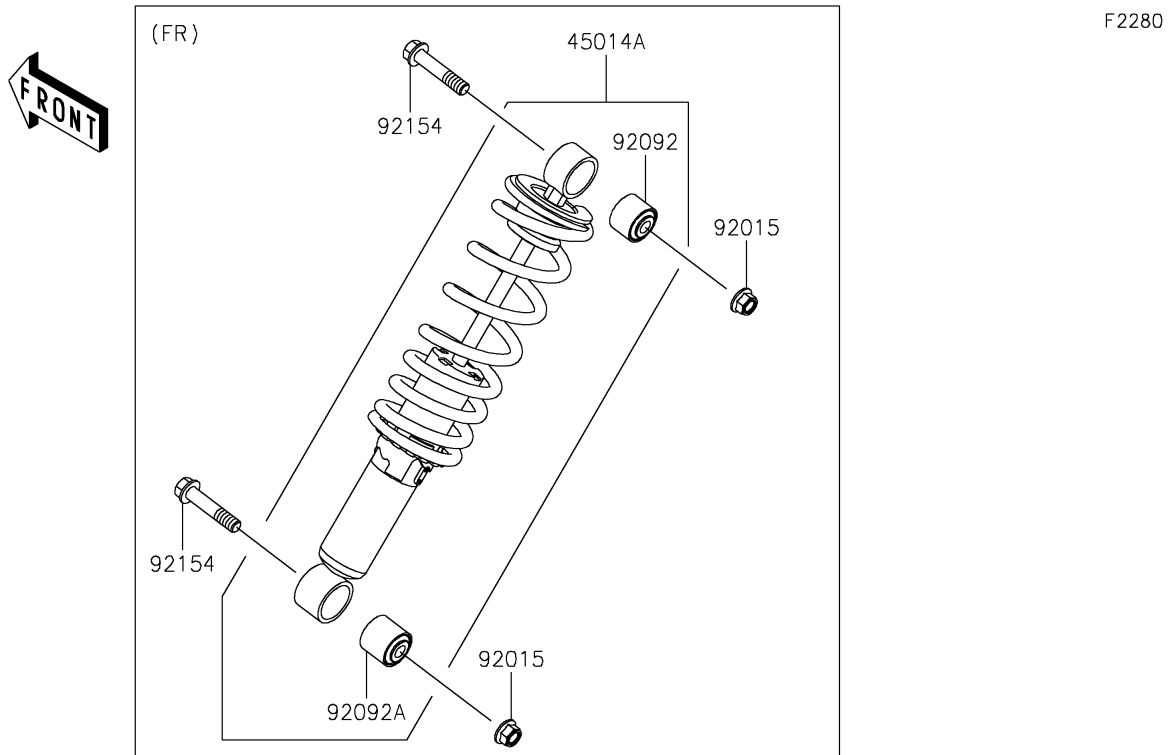

2024 MULE PRO-FXT 1000 LE Ranch Edition



PARTS LIST

Shock Absorber(s)

ITEM NAME	PART NUMBER	QUANTITY
-----------	-------------	----------
