

# 2024 MULE PRO-FXT 1000 LE Ranch Edition

## PARTS DIAGRAM

### Rear Hubs/Brakes

F2240

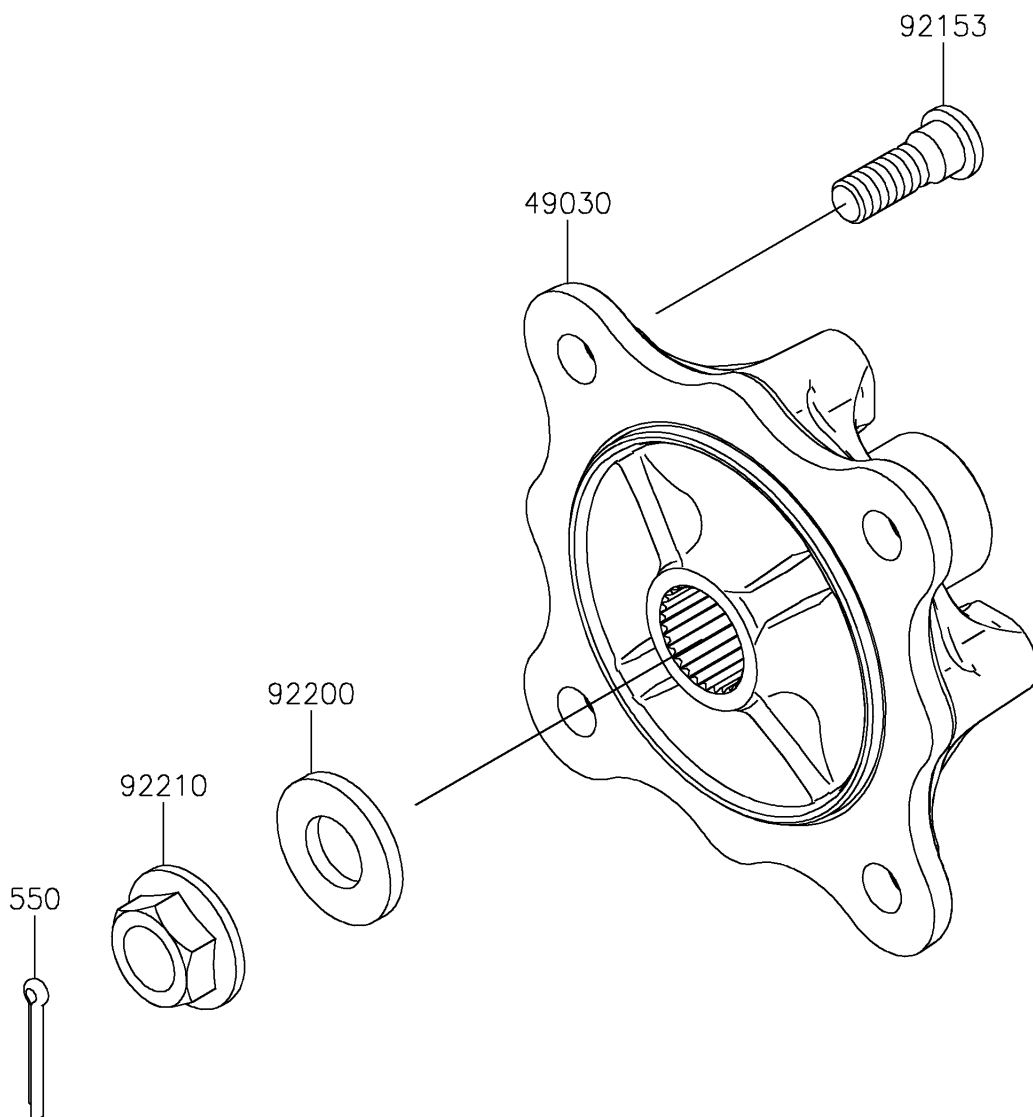

# 2024 MULE PRO-FXT 1000 LE Ranch Edition



## PARTS LIST

### Rear Hubs/Brakes

ITEM NAME	PART NUMBER	QUANTITY
-----------	-------------	----------

---