

# 2025 MULE PRO-FXT 1000 LE Ranch Edition

## PARTS DIAGRAM

### Fuel Injection

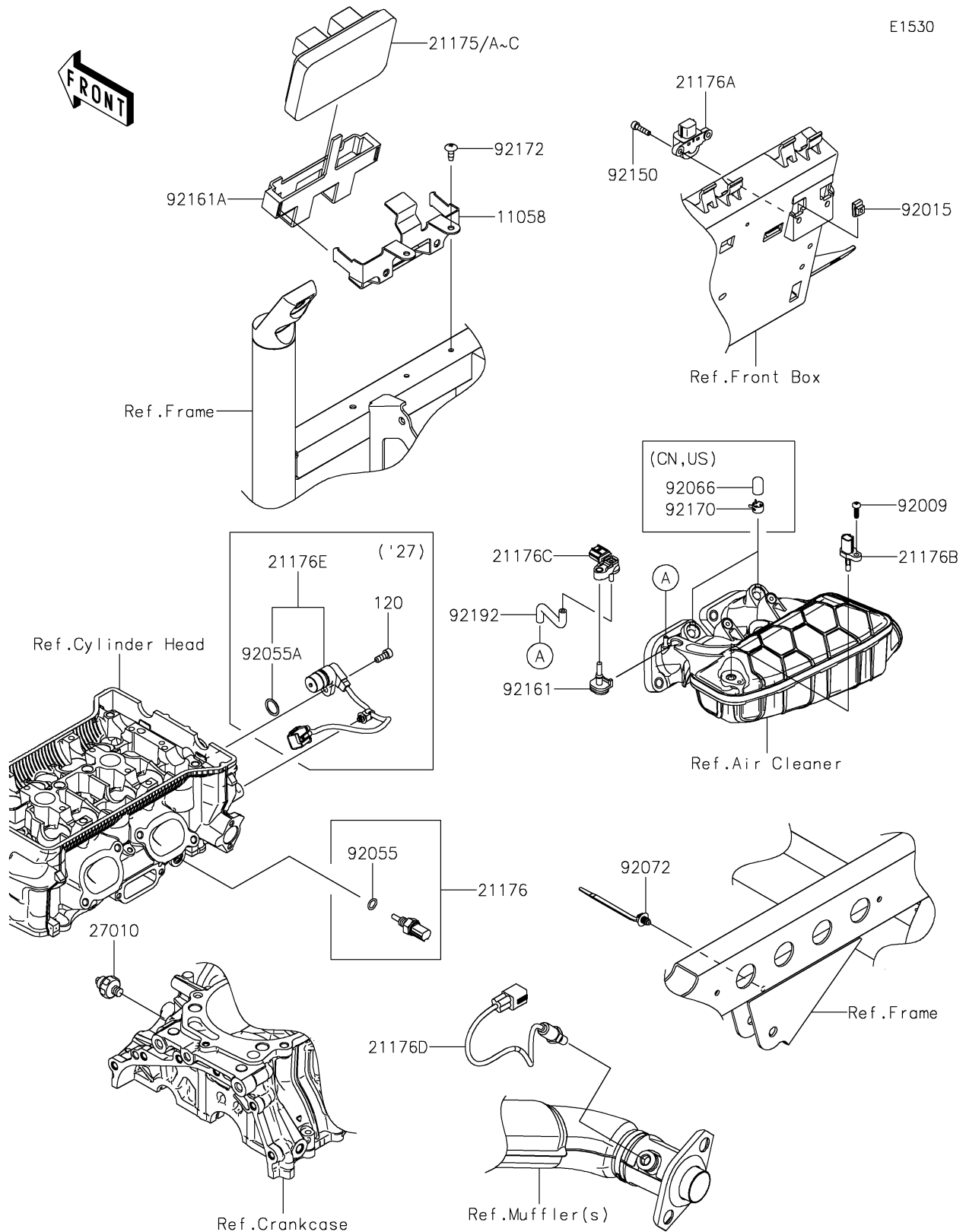

E1530

# 2025 MULE PRO-FXT 1000 LE Ranch Edition



## PARTS LIST

### Fuel Injection

ITEM NAME	PART NUMBER	QUANTITY
BRACKET,ECU (Ref # 11058)	11058-0323	1
CONTROL UNIT-ELECTRONIC (Ref # 21175)	21175-1853	1
CONTROL UNIT-ELECTRONIC (Ref # 21175A)	21175-1877	1
SENSOR,WATER TEMP (Ref # 21176)	21176-0009	1
SENSOR,VEHICLE-DOWN (Ref # 21176A)	21176-0026	1
SENSOR,AIR TEMPERATURE (Ref # 21176B)	21176-0048	1
SENSOR,PRESSURE (Ref # 21176C)	21176-0906	1
SENSOR,OXYGEN (Ref # 21176D)	21176-1192	1
SWITCH,OIL PRESSURE (Ref # 27010)	27010-1313	1
SCREW,TAPPING,5X16 (Ref # 92009)	92009-1264	1
NUT,5MM (Ref # 92015)	92015-1627	2
RING-O,9.5X1.9 (Ref # 92055)	92055-0016	1
PLUG (Ref # 92066)	92066-0862	2
BAND,OS170-FT7(BLACK) (Ref # 92072)	92072-1414	1
BOLT,SOCKET,5X20 (Ref # 92150)	92150-1019	2
DAMPER (Ref # 92161)	92161-0673	1
DAMPER,ECU (Ref # 92161A)	92161-2481	1
CLAMP (Ref # 92170)	92170-2043	2
SCREW,TAPPING,6X16 (Ref # 92172)	92172-0739	2
TUBE (Ref # 92192)	92192-2633	1