

# 2026 Teryx KRX4 1000

## PARTS DIAGRAM

### Ignition Switch

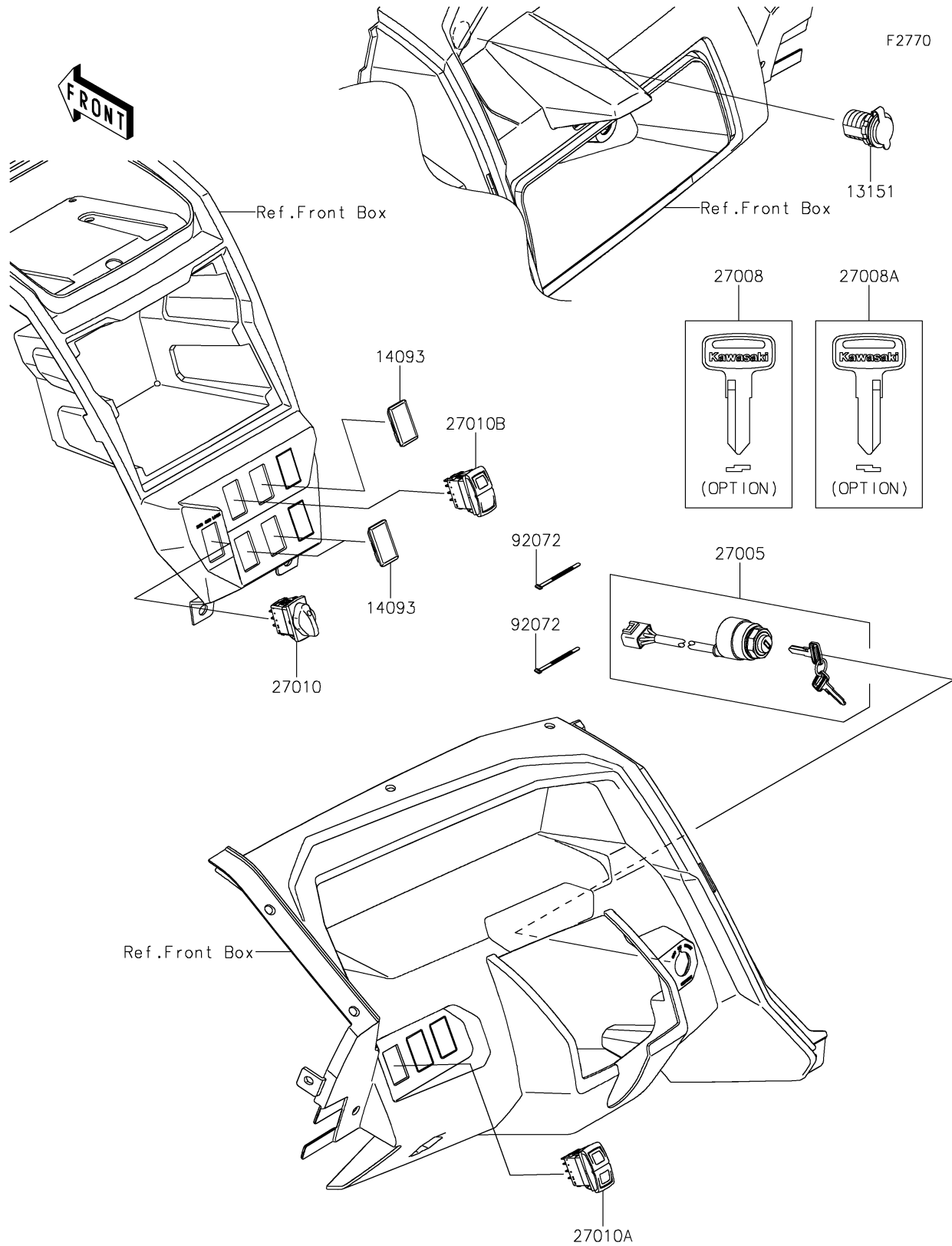

# 2026 Teryx KRX4 1000

## PARTS LIST

### Ignition Switch

ITEM NAME	PART NUMBER	QUANTITY
SWITCH-COMP,OUTLET,12V (Ref # 13151)	13151-0556	1
COVER,SWITCH (Ref # 14093)	14093-1202	3
SWITCH-ASSY-IGNITION (Ref # 27005)	27005-0643	1
KEY-LOCK,BLANK (Ref # 27008)	27008-1153	1
KEY-LOCK,BLANK (Ref # 27008A)	27008-1157	1
SWITCH,2WD/4WD (Ref # 27010)	27010-0902	1
SWITCH,HEAD LIGHT (Ref # 27010A)	27010-0903	1
SWITCH,POWER MODE (Ref # 27010B)	27010-0904	1
BAND,L=123 (Ref # 92072)	92072-030	2