

2026 TERYX® KRX4™ 1000

PARTS DIAGRAM

Door(Rear)

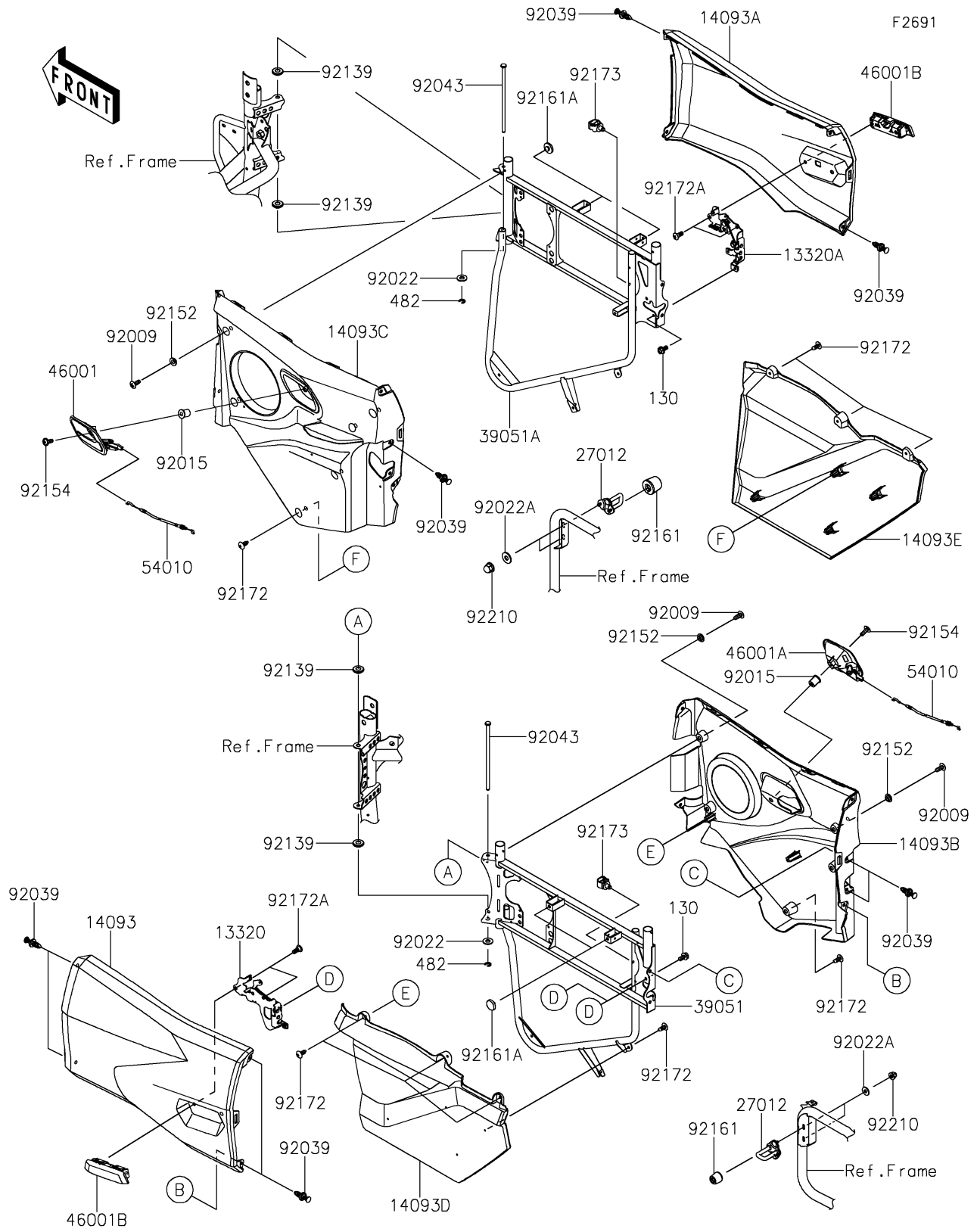

2026 TERYX® KRX4™ 1000

PARTS LIST

Door(Rear)

ITEM NAME	PART NUMBER	QUANTITY
LEVER-ASSY,LATCH,RR,LH (Ref # 13320)	13320-0587	1
LEVER-ASSY,LATCH,RR,RH (Ref # 13320A)	13320-0588	1
COVER,DOOR,RR,LH,UPP,S.BLACK (Ref # 14093)	14093-1219-839	1
COVER,DOOR,RR,RH,UPP,S.BLACK (Ref # 14093A)	14093-1220-839	1
COVER,DOOR,RR,LH,INNER (Ref # 14093B)	14093-1221	1
COVER,DOOR,RR,RH,INNER (Ref # 14093C)	14093-1222	1
COVER,DOOR,RR,LH,LWR (Ref # 14093D)	14093-1223	1
COVER,DOOR,RR,RH,LWR (Ref # 14093E)	14093-1224	1
HOOK,DOOR (Ref # 27012)	27012-0860	2
FRAME-COMP-SIDE,RR,LH (Ref # 39051)	39051-0025	1
FRAME-COMP-SIDE,RR,RH (Ref # 39051A)	39051-0026	1
HANDLE-ASSY,DOOR,RH,INNER (Ref # 46001)	46001-0015	1
HANDLE-ASSY,DOOR,LH,INNER (Ref # 46001A)	46001-0016	1
HANDLE-ASSY,DOOR,OUTER (Ref # 46001B)	46001-0017	2
CABLE (Ref # 54010)	54010-0651	2
SCREW,TAPPING,6X16 (Ref # 92009)	92009-1166	10
NUT (Ref # 92015)	92015-1700	2
WASHER,8.2X18X1.5 (Ref # 92022)	92022-1964	2
WASHER,6.5X16X1.6 (Ref # 92022A)	92022-2247	4
RIVET (Ref # 92039)	92039-0865	12
PIN,DOOR (Ref # 92043)	92043-1785	2
BUSHING,DOOR (Ref # 92139)	92139-1215	4
COLLAR,6.3X9.5X4.1 (Ref # 92152)	92152-1571	10
BOLT,SOCKET,6X16 (Ref # 92154)	92154-4068	2
DAMPER,9X28X24.3 (Ref # 92161)	92161-1456	2
DAMPER (Ref # 92161A)	92161-2342	4
SCREW,6X16 (Ref # 92172)	92172-0284	14
SCREW,6X16 (Ref # 92172A)	92172-1333	4
CLAMP,12MM DIA. (Ref # 92173)	92173-0736	2

2026 TERYX® KRX4™ 1000

PARTS LIST

Door(Rear)

ITEM NAME	PART NUMBER	QUANTITY
NUT,CAP,6MM (Ref # 92210)	92210-0003	4
BOLT-FLANGED,6X12 (Ref # 130)	130CA0612	4
CIRCLIP-TYPE-E,6MM (Ref # 482)	482J6000	2