

2026 Teryx KRX4 1000

PARTS DIAGRAM

Seat(Rear)

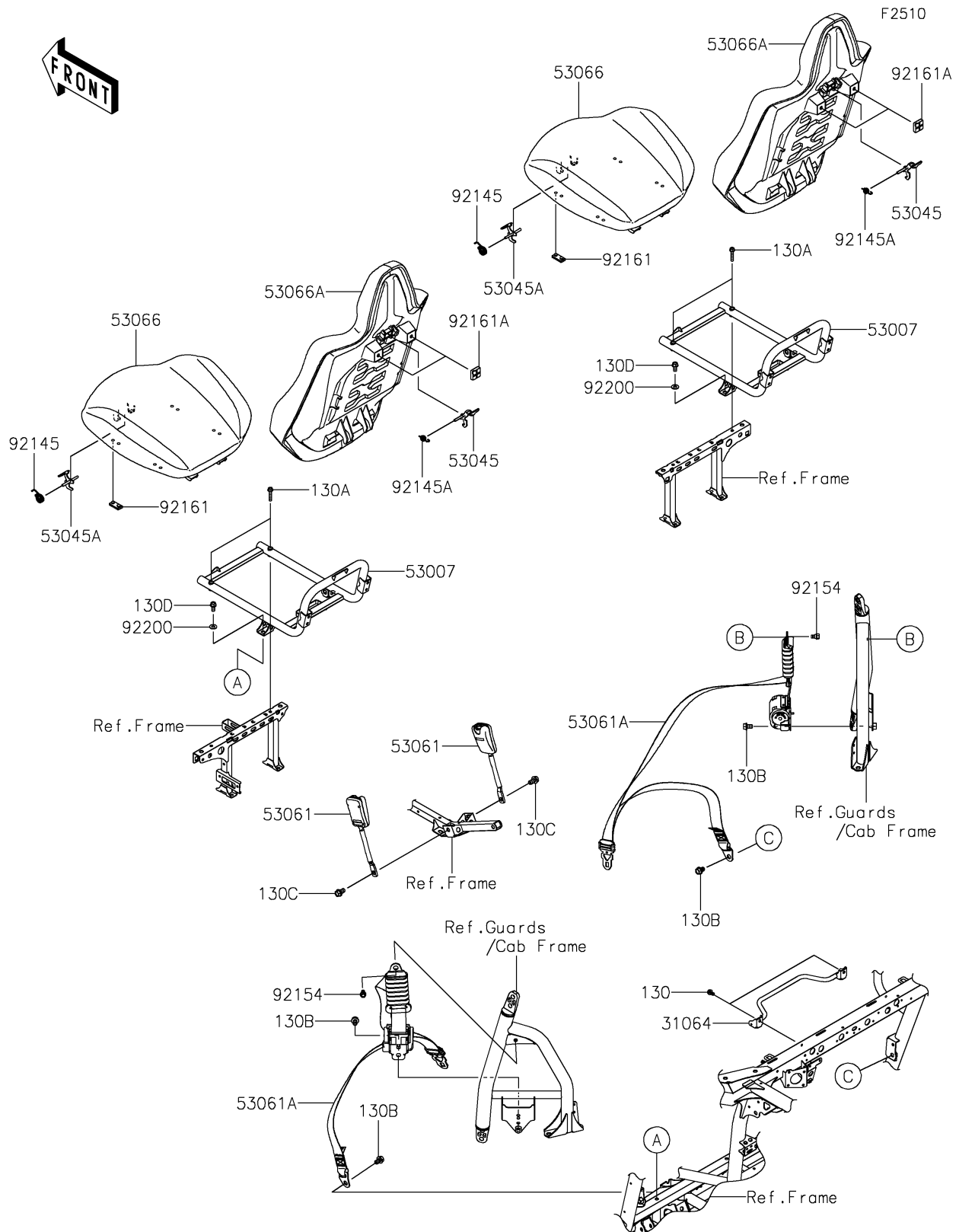

2026 Teryx KRX4 1000

PARTS LIST

Seat(Rear)

ITEM NAME	PART NUMBER	QUANTITY
PIPE-COMP,RR,SEAT SUPPORT (Ref # 31064)	31064-0742	1
FRAME-SEAT (Ref # 53007)	53007-0446	2
HOOK-ASSY,SEAT BACK (Ref # 53045)	53045-0037	2
HOOK-ASSY,SEAT BOTTOM (Ref # 53045A)	53045-0039	2
BELT-SEAT,BUCKLE (Ref # 53061)	53061-0039	2
BELT-SEAT,RETRACTOR (Ref # 53061A)	53061-0369	2
SEAT-ASSY,BOTTOM,BLACK+BLK (Ref # 53066)	53066-0975-71Q	2
SEAT-ASSY,BACK,SIL+BLK+SIL (Ref # 53066A)	53066-0976-64L	2
SPRING,SEAT LATCH (Ref # 92145)	92145-0022	2
SPRING (Ref # 92145A)	92145-2235	2
BOLT,FLANGED,10X16 (Ref # 92154)	92154-2089	2
DAMPER,SEAT (Ref # 92161)	92161-1489	8
DAMPER,10X34X10 (Ref # 92161A)	92161-1920	4
WASHER,10.3X23X1.6 (Ref # 92200)	92200-0724	4
BOLT-FLANGED,8X14 (Ref # 130)	130BA0814	2
BOLT-FLANGED,8X40 (Ref # 130A)	130BA0840	4
BOLT-FLANGED,12X18 (Ref # 130B)	130BA1218	4
BOLT-FLANGED,12X22 (Ref # 130C)	130BA1222	2
BOLT-FLANGED,10X20 (Ref # 130D)	130CA1020	4