

# 2026 Teryx KRX4 1000

## PARTS DIAGRAM

### Generator

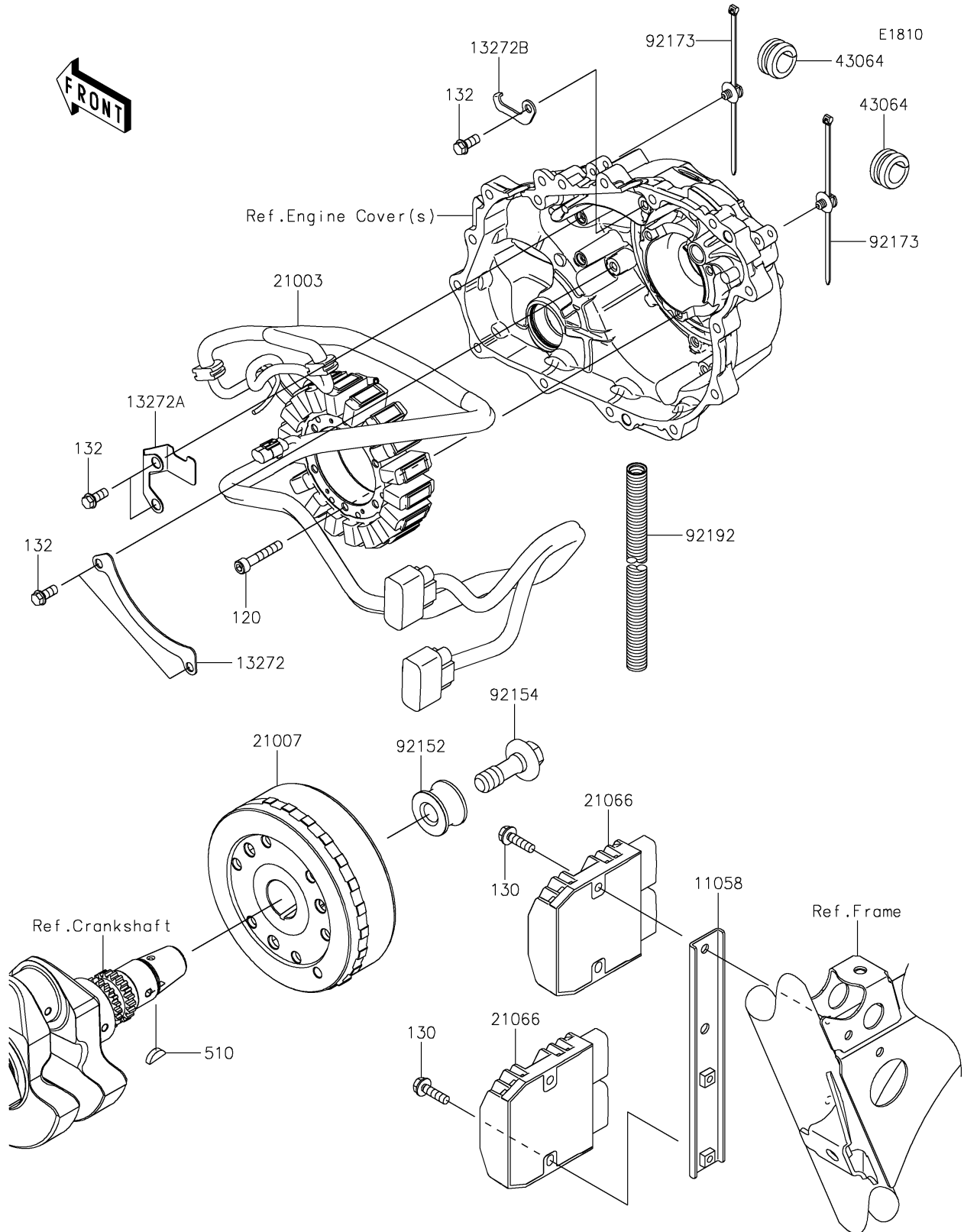

# 2026 Teryx KRX4 1000

## PARTS LIST

### Generator

ITEM NAME	PART NUMBER	QUANTITY
BRACKET (Ref # 11058)	11058-1382	1
PLATE,LEAD WIRE (Ref # 13272)	13272-4318	1
PLATE,LEAD WIRE (Ref # 13272A)	13272-7132	1
PLATE,LEAD WIRE (Ref # 13272B)	13272-7133	1
STATOR (Ref # 21003)	21003-0228	1
ROTOR (Ref # 21007)	21007-0738	1
REGULATOR-VOLTAGE (Ref # 21066)	21066-0771	2
GROMMET,HOSE CLAMP (Ref # 43064)	43064-007	2
COLLAR (Ref # 92152)	92152-3816	1
BOLT (Ref # 92154)	92154-7265	1
CLAMP (Ref # 92173)	92173-2792	2
TUBE,CONVOLUTED,10.7X14.1X140 (Ref # 92192)	92192-2521	1
BOLT-SOCKET,6X35 (Ref # 120)	120CA0635	3
BOLT-FLANGED,6X22 (Ref # 130)	130BA0622	4
BOLT-FLANGED-SMALL,6X14 (Ref # 132)	132BA0614	5
KEY-WOODRUFF (Ref # 510)	510A4200	1