

# 2026 Teryx KRX4 1000

## PARTS DIAGRAM

### Cylinder Head

E1111

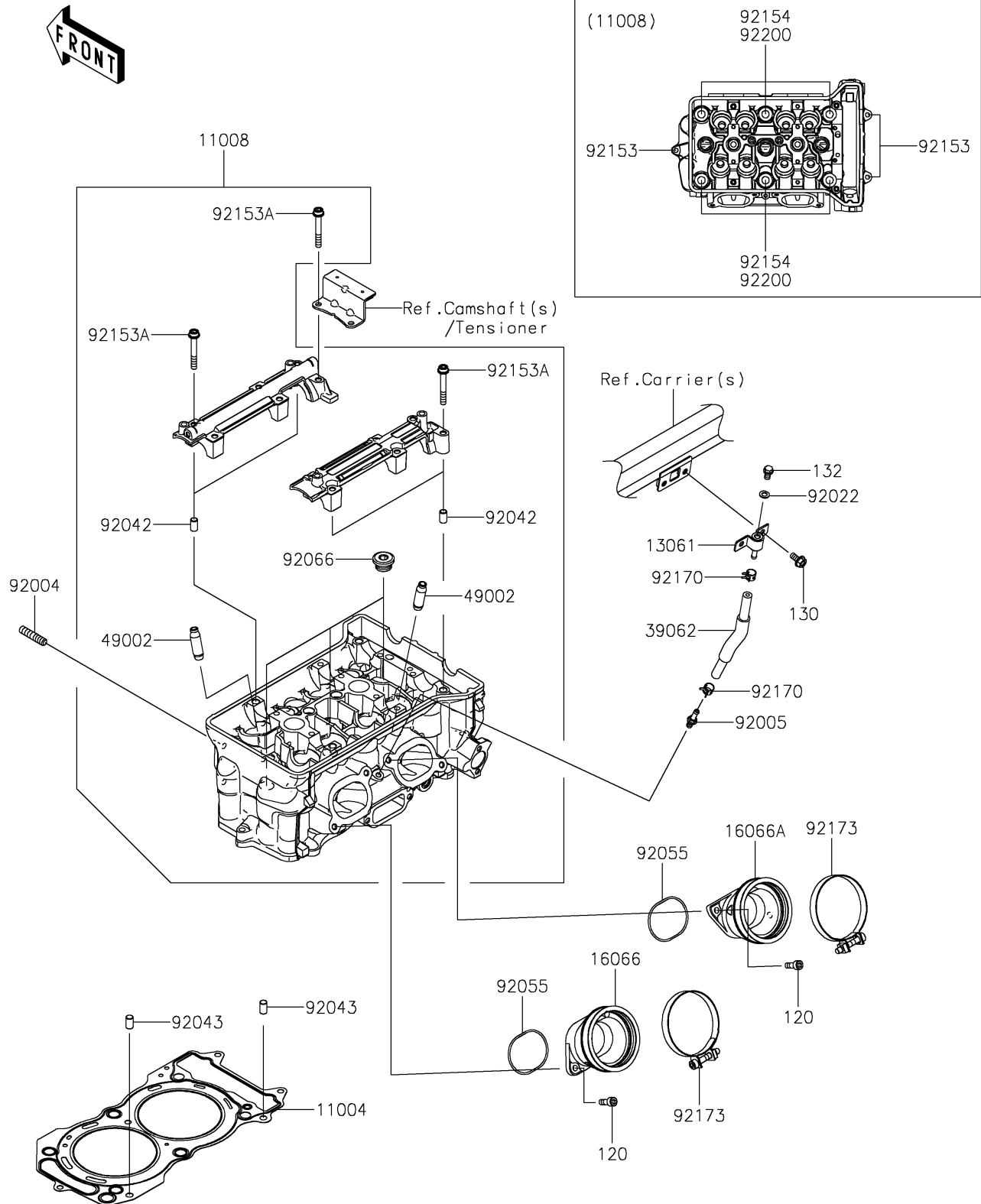

# 2026 Teryx KRX4 1000

## PARTS LIST

### Cylinder Head

ITEM NAME	PART NUMBER	QUANTITY
GASKET-HEAD (Ref # 11004)	11004-0785	1
HEAD-COMP-CYLINDER (Ref # 11008)	11008-1461	1
BOSS (Ref # 13061)	13061-0977	1
HOLDER-THROTTLE BODY,#1 (Ref # 16066)	16066-0015	1
HOLDER-THROTTLE BODY,#2 (Ref # 16066A)	16066-0016	1
HOSE-COOLING,CYL.HEAD-AIR VENT (Ref # 39062)	39062-0862	1
GUIDE-VALVE (Ref # 49002)	49002-0709	8
STUD,8X22 (Ref # 92004)	92004-1217	8
FITTING (Ref # 92005)	92005-0826	1
WASHER,6.2X11X1 (Ref # 92022)	92022-304	1
PIN,DOWEL,6.3X8X14 (Ref # 92042)	92042-007	4
PIN,8X14 (Ref # 92043)	92043-1567	2
RING-O,49.7X1.9 (Ref # 92055)	92055-0930	2
PLUG,18X10 (Ref # 92066)	92066-0832	3
BOLT,6X95 (Ref # 92153)	92153-0320	3
BOLT,SOCKET,6X45 (Ref # 92153A)	92153-0656	12
BOLT,11X157 (Ref # 92154)	92154-3931	6
CLAMP (Ref # 92170)	92170-1493	2
CLAMP,72MM (Ref # 92173)	92173-2025	2
WASHER,11.5X20.5X3.2 (Ref # 92200)	92200-0727	6
BOLT-SOCKET,6X18 (Ref # 120)	120CA0618	4
BOLT-FLANGED,6X12 (Ref # 130)	130BA0612	2
BOLT-FLANGED-SMALL,6X10 (Ref # 132)	132BA0610	1