

2024 MULE PRO-FXT™ 1000 PLATINUM RANCH EDITION

PARTS DIAGRAM

Labels

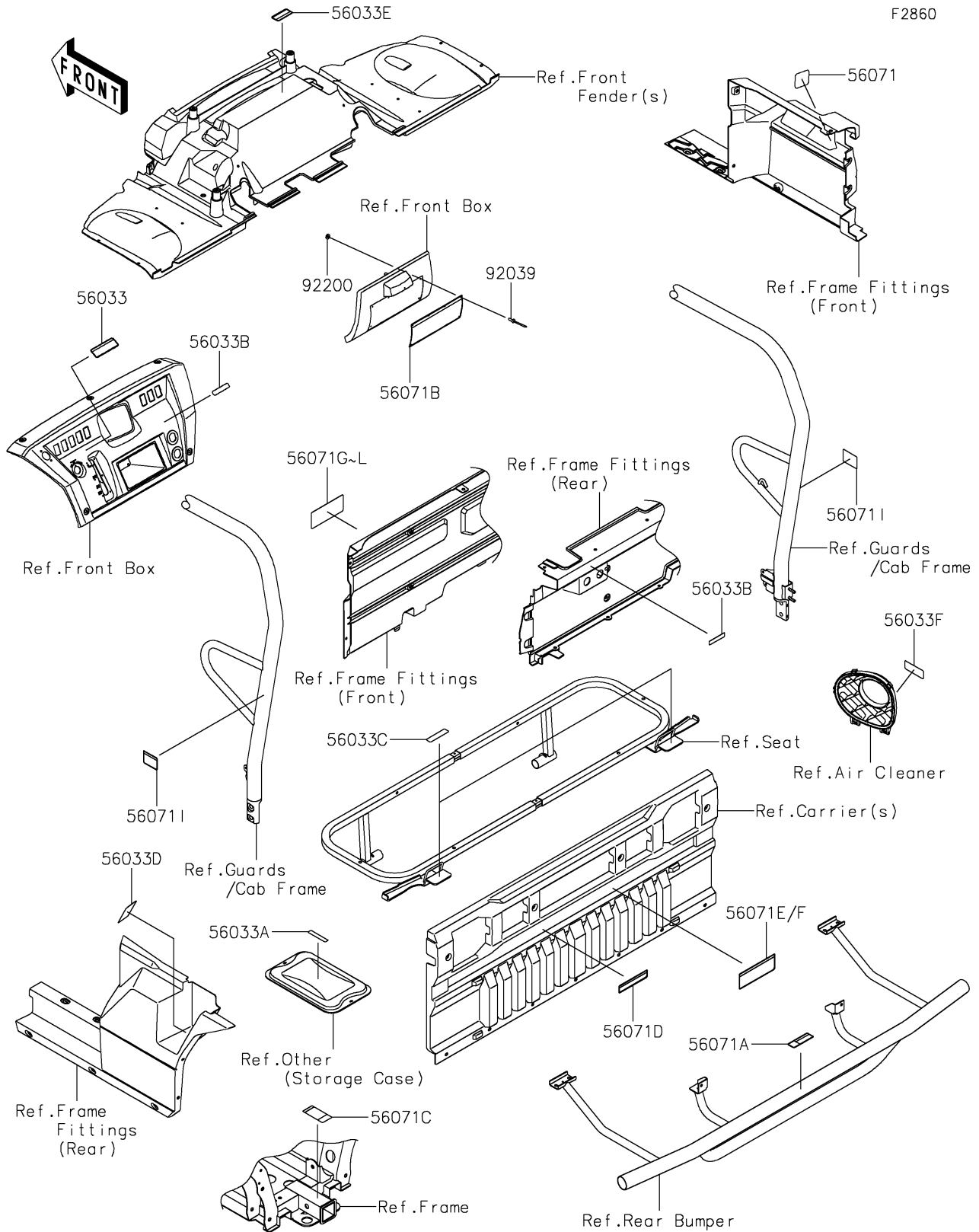

2024 MULE PRO-FXT™ 1000 PLATINUM RANCH EDITION



PARTS LIST Labels

ITEM NAME	PART NUMBER	QUANTITY
-----------	-------------	----------
