

2025 MULE PRO-FXT 1000 Platinum

PARTS DIAGRAM

Other(Winch)(DRFNN-DTFNL)

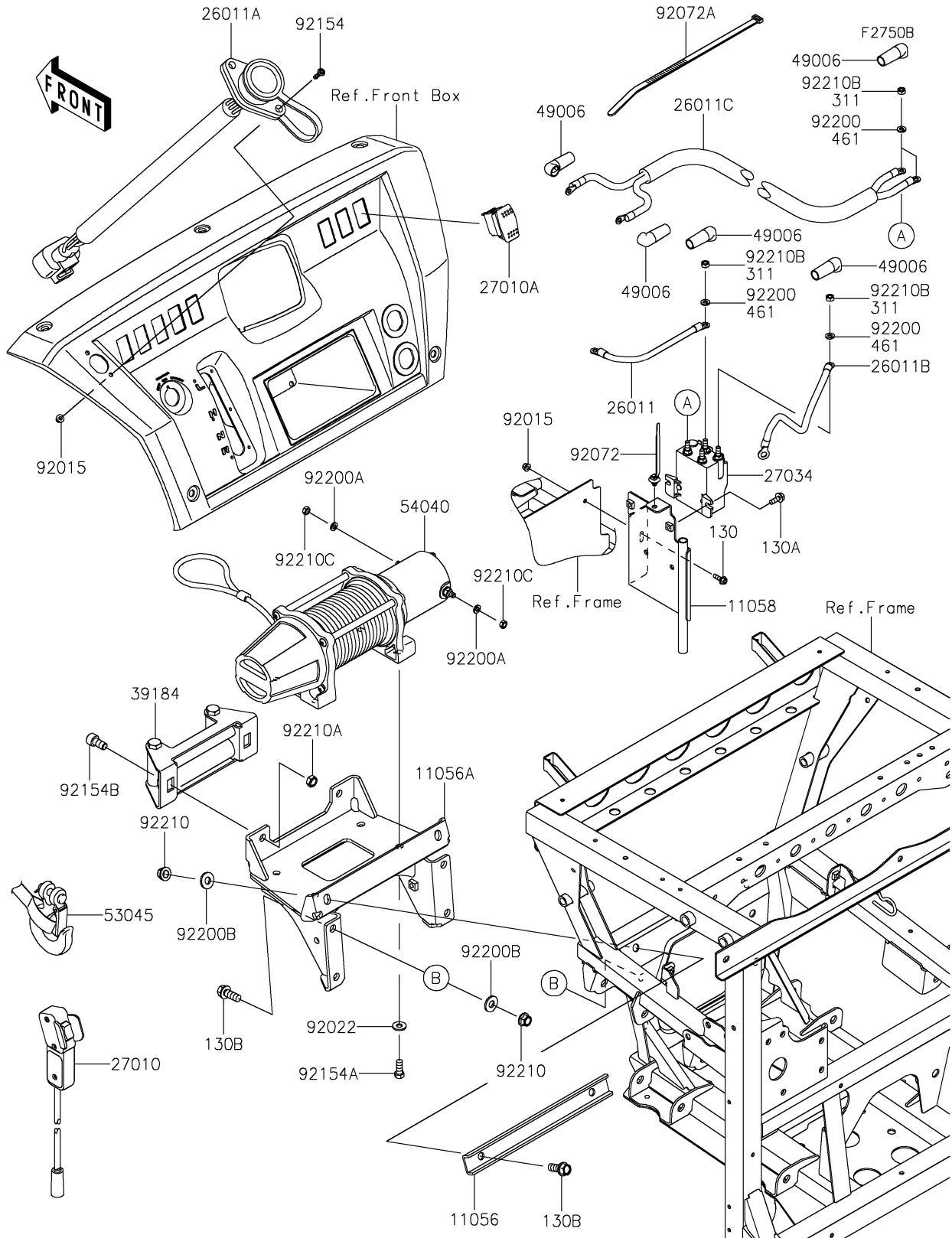

2025 MULE PRO-FXT 1000 Platinum

Kawasaki
Let the Good Times Roll®

PARTS LIST

Other(Winch)(DRFNN-DTFNL)

ITEM NAME	PART NUMBER	QUANTITY
BRACKET (Ref # 11056)	11056-4074	1
BRACKET,WINCH (Ref # 11056A)	11056-7783	1
BRACKET (Ref # 11058)	11058-0997	1
WIRE-LEAD,RED (Ref # 26011)	26011-0916	1
WIRE-LEAD,REMOTE SWITCH (Ref # 26011A)	26011-0935	1
WIRE-LEAD,BLACK (Ref # 26011B)	26011-0989	1
WIRE-LEAD,BLUE/YELLOW (Ref # 26011C)	26011-0990	1
SWITCH,REMOTE (Ref # 27010)	27010-0820	1
SWITCH,CARLING (Ref # 27010A)	27010-0821	1
RELAY,CONTACTOR (Ref # 27034)	27034-0008	1
BRACKET-ASSY,FAIRLEAD (Ref # 39184)	39184-0740	1
BOOT (Ref # 49006)	49006-0601	6
HOOK-ASSY (Ref # 53045)	53045-0028	1
WINCH (Ref # 54040)	54040-0008	1
NUT,LOCK,FLANGED,5MM (Ref # 92015)	92015-1752	3
WASHER,8.2X19X2 (Ref # 92022)	92022-1533	4
BAND,OS170-FT7(BLACK) (Ref # 92072)	92072-1414	1
BAND,L=292.1 (Ref # 92072A)	92072-3509	5
BOLT,SOCKET,5X20 (Ref # 92154)	92154-0829	2
BOLT,8X20 (Ref # 92154A)	92154-1876	4
BOLT,SOCKET,10X20 (Ref # 92154B)	92154-1877	2
WASHER,6 LOCK (Ref # 92200)	92200-1776	4
WASHER,6.4X12X1.8 (Ref # 92200A)	92200-2358	2
WASHER,10.2X23X2.5 (Ref # 92200B)	92200-7506	6
NUT,LOCK,FLANGED,10MM (Ref # 92210)	92210-1080	6
NUT,LOCK,M10 (Ref # 92210A)	92210-1432	2
NUT,M6X1.00 (Ref # 92210B)	92210-1434	4
NUT,6MM (Ref # 92210C)	92210-1792	2
BOLT-FLANGED,5X16 (Ref # 130)	130BA0516	1

2025 MULE PRO-FXT 1000 Platinum



PARTS LIST

Other(Winch)(DRFNN-DTFNL)

ITEM NAME	PART NUMBER	QUANTITY
BOLT-FLANGED,6X16 (Ref # 130A)	130BA0616	2
BOLT-FLANGED,10X25 (Ref # 130B)	130BB1025	6