

# 2026 MULE PRO-FXT™ 1000 PLATINUM RANCH EDITION

## PARTS DIAGRAM Shock Absorber(s)

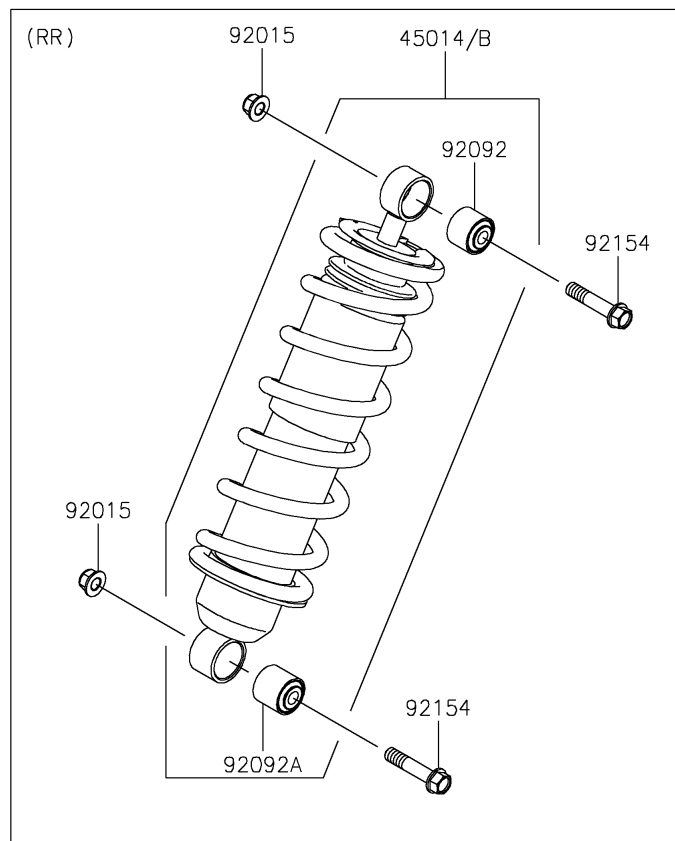

# 2026 MULE PRO-FXT™ 1000 PLATINUM RANCH EDITION

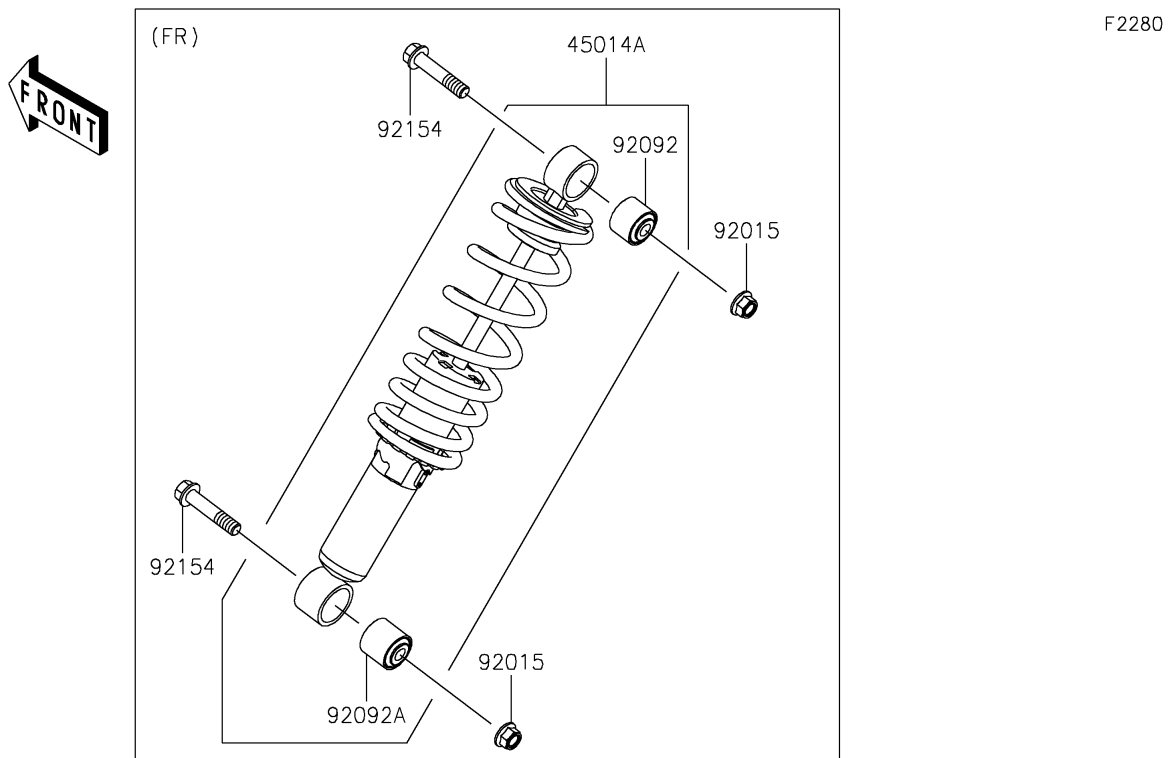

## PARTS LIST

### Shock Absorber(s)

ITEM NAME	PART NUMBER	QUANTITY
SHOCKABSORBER,RR,F.SILVER (Ref # 45014)	45014-0773-42P	2
SHOCKABSORBER,FR,F.SILVER (Ref # 45014A)	45014-0776-42P	2
SHOCKABSORBER,RR,F.SILVER (Ref # 45014B)	45014-0793-42P	2
NUT,LOCK,FLANGED,12MM (Ref # 92015)	92015-1433	8
BUSHING-RUBBER,UPP (Ref # 92092)	92092-0034	4
BUSHING-RUBBER,LWR (Ref # 92092A)	92092-0035	4
BOLT,FLANGED,12X58 (Ref # 92154)	92154-1319	8