

# 2024 MULE PRO-FXT™ 1000 PLATINUM RANCH EDITION

## PARTS DIAGRAM Front Suspension

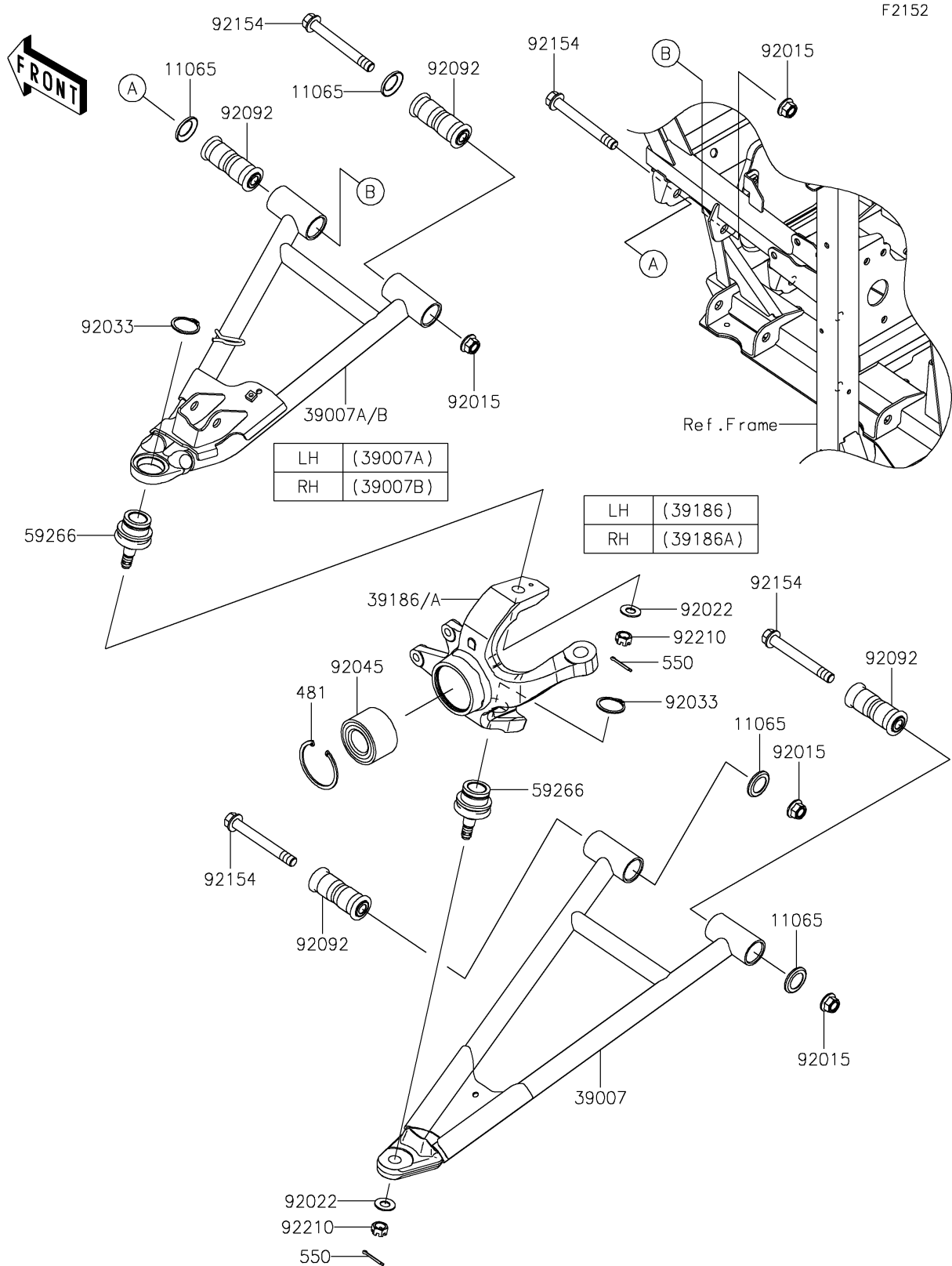

# 2024 MULE PRO-FXT™ 1000 PLATINUM RANCH EDITION



## PARTS LIST

### Front Suspension

ITEM NAME	PART NUMBER	QUANTITY
-----------	-------------	----------

---