

2011 KLR™ 650

PARTS DIAGRAM

Gear Change Mechanism

E1370

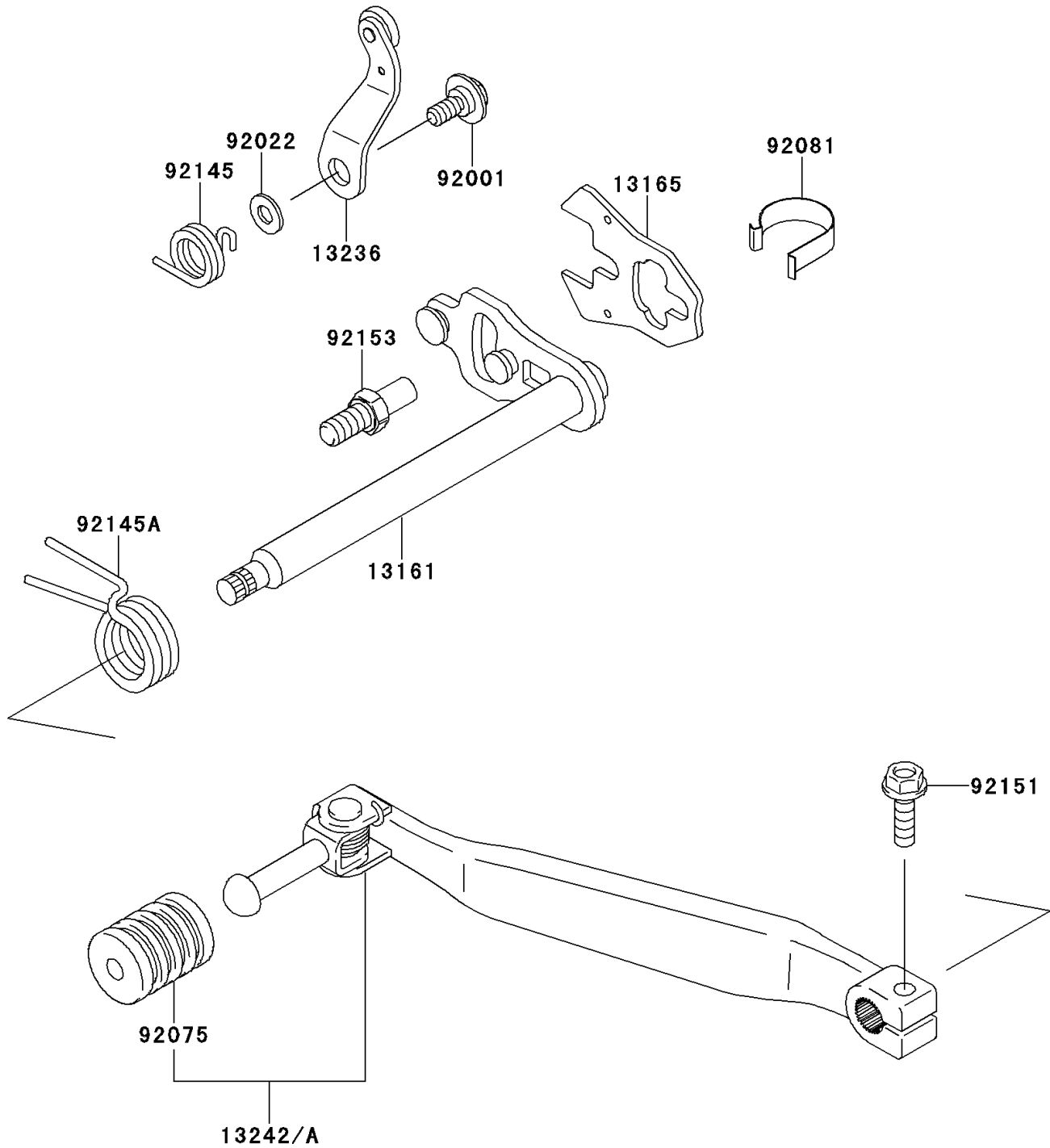

2011 KLR™ 650

PARTS LIST

Gear Change Mechanism

Kawasaki

Let the Good Times Roll®

ITEM NAME

PART NUMBER

QUANTITY
