

2026 MULE PRO-FXT™ 1000 LE

PARTS DIAGRAM

Oil Pump/Oil Filter

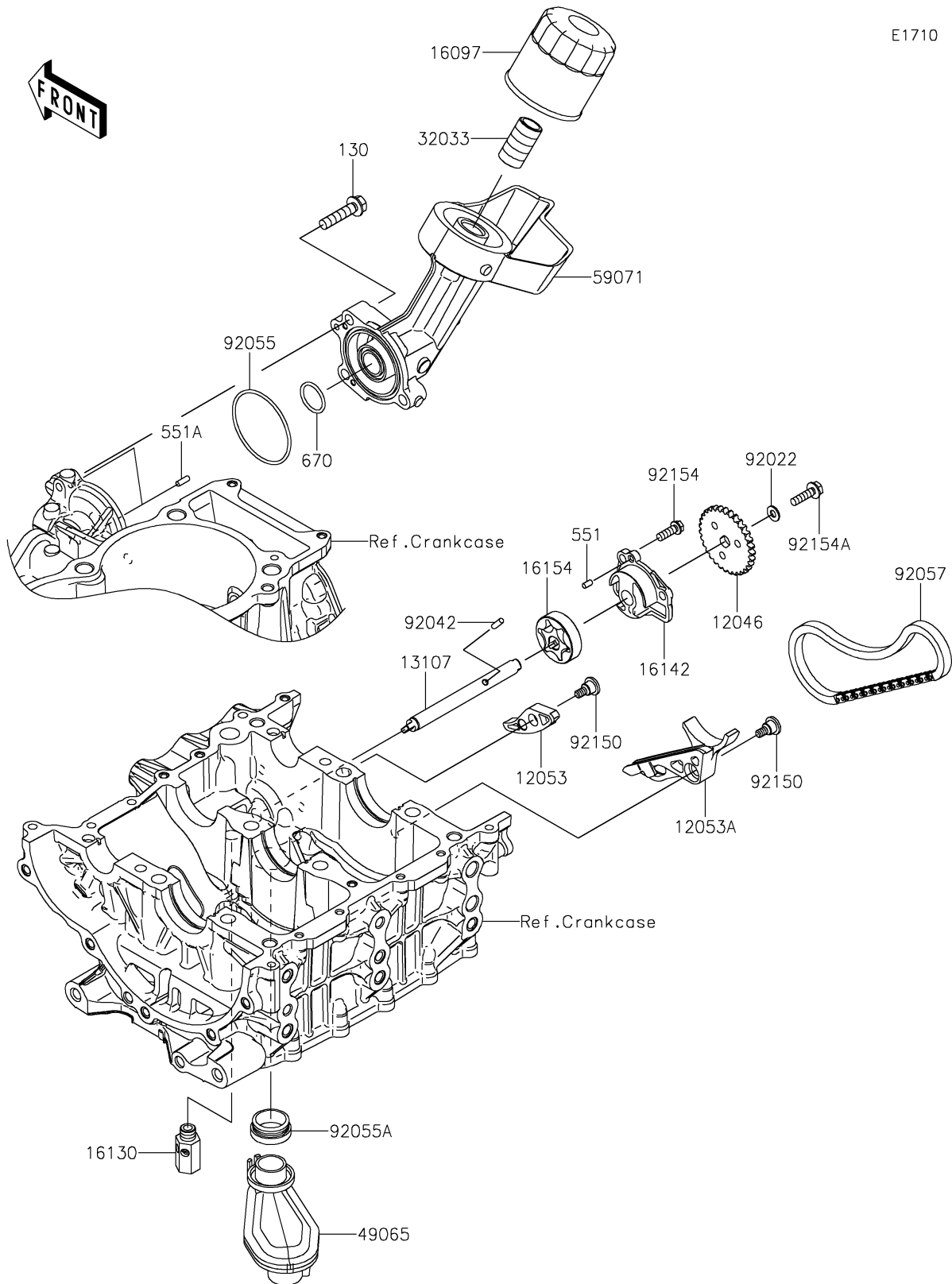

2026 MULE PRO-FXT™ 1000 LE

PARTS LIST

Oil Pump/Oil Filter

ITEM NAME	PART NUMBER	QUANTITY
SPROCKET,OIL PUMP,31T (Ref # 12046)	12046-0614	1
GUIDE-CHAIN,UPP (Ref # 12053)	12053-0374	1
GUIDE-CHAIN,LWR (Ref # 12053A)	12053-0375	1
SHAFT,OIL PUMP (Ref # 13107)	13107-0896	1
FILTER-ASSY-OIL (Ref # 16097)	16097-0007	1
VALVE-ASSY-RELIEF (Ref # 16130)	16130-1058	1
COVER-PUMP (Ref # 16142)	16142-0774	1
ROTOR-PUMP (Ref # 16154)	16154-0779	1
PIPE,OIL FILTER (Ref # 32033)	32033-1535	1
FILTER-OIL (Ref # 49065)	49065-0729	1
JOINT,OIL FILTER (Ref # 59071)	59071-0800	1
WASHER,6X12.8X1.2 (Ref # 92022)	92022-1827	1
PIN,DOWEL,4X13.8 (Ref # 92042)	92042-030	1
RING-O,59.5X2.4 (Ref # 92055)	92055-0753	1
RING-O,OIL FILTER (Ref # 92055A)	92055-1503	1
CHAIN,98XRH2010-70M (Ref # 92057)	92057-0765	1
BOLT,6MM (Ref # 92150)	92150-1090	2
BOLT,FLANGED,6X18 (Ref # 92154)	92154-0499	3
BOLT,FLANGED,6X22 (Ref # 92154A)	92154-1525	1
BOLT-FLANGED,8X35 (Ref # 130)	130BA0835	3
PIN-DOWEL,4X8 (Ref # 551)	551A0408	1
PIN-DOWEL (Ref # 551A)	551A0412	2
O RING,22MM (Ref # 670)	670D2022	1