

2025 MULE PRO-FXR 1000

PARTS DIAGRAM

Drive Shaft-Front

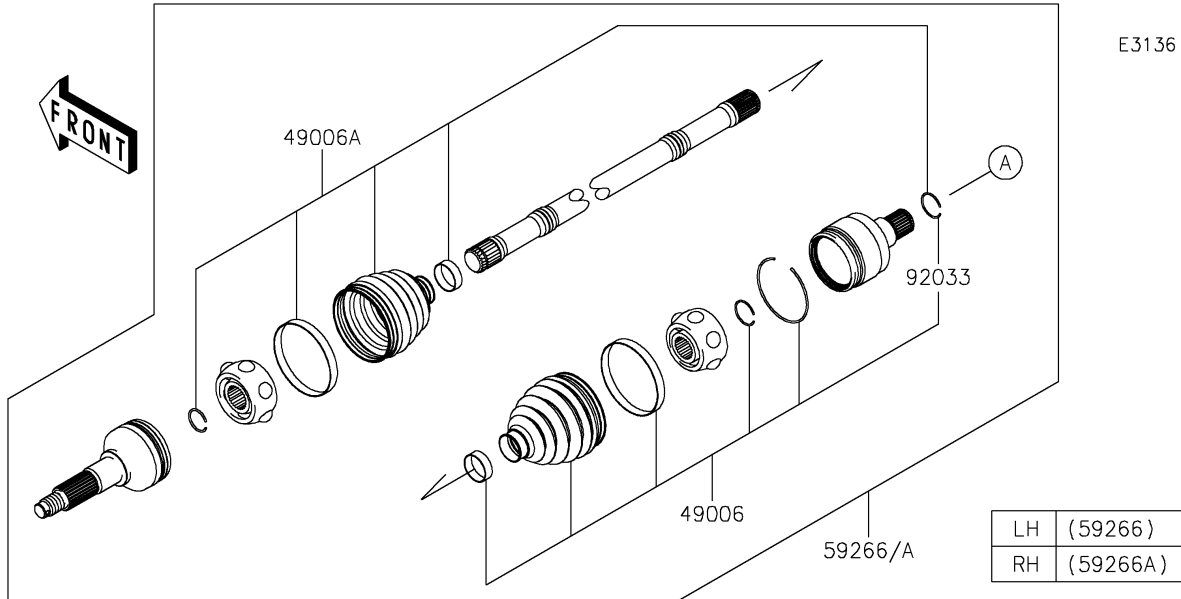

E3136

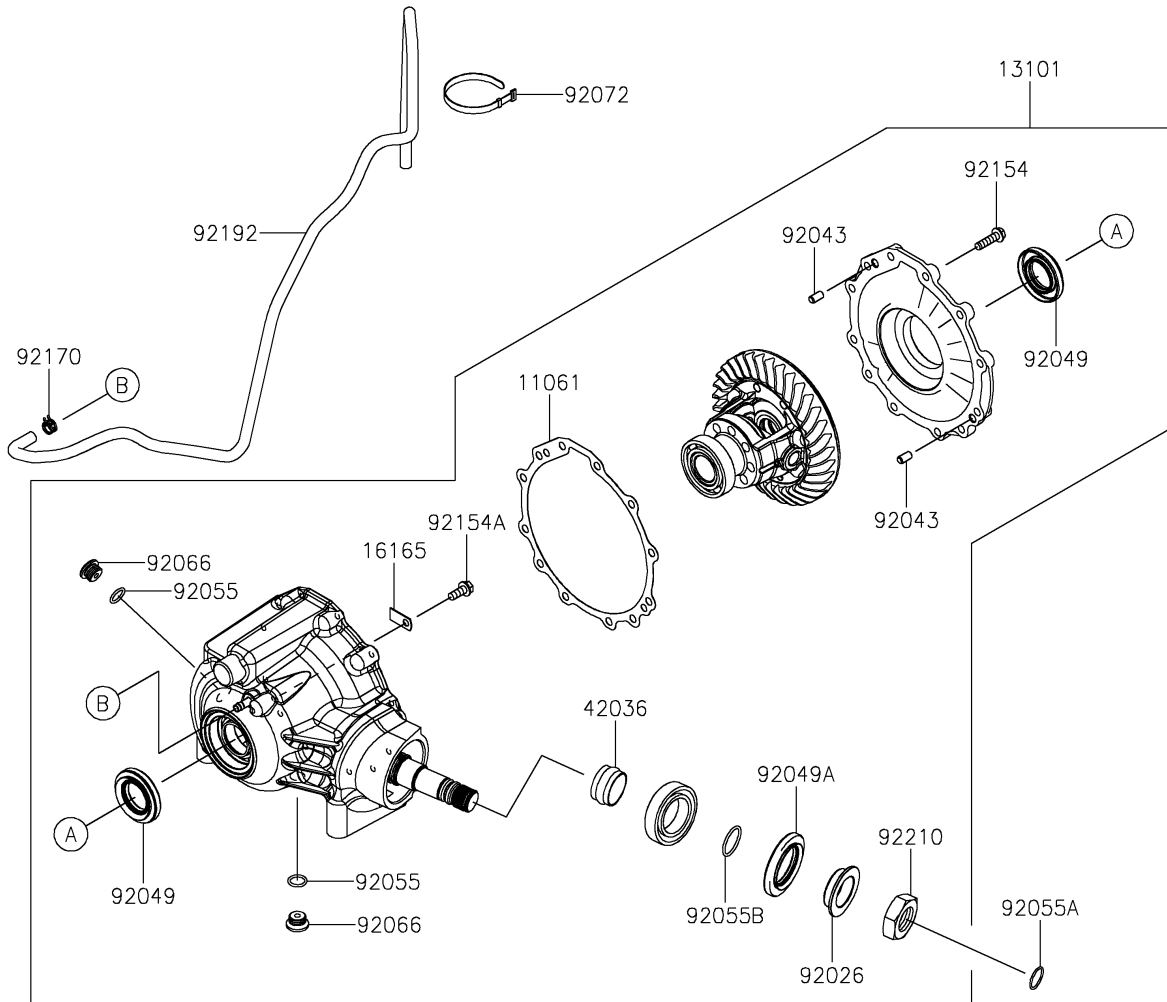

2025 MULE PRO-FXR 1000

PARTS LIST

Drive Shaft-Front

ITEM NAME	PART NUMBER	QUANTITY
GASKET,CASE (Ref # 11061)	11061-1413	1
GEAR-ASSY,FRONT DIFFERENTIAL (Ref # 13101)	13101-0687	1
SEPARATOR (Ref # 16165)	16165-0019	1
SLEEVE (Ref # 42036)	42036-0873	1
BOOT,INSIDE (Ref # 49006)	49006-0641	2
BOOT,OUTSIDE (Ref # 49006A)	49006-0681	2
JOINT-BALL,FR,LH (Ref # 59266)	59266-0763	1
JOINT-BALL,FR,RH (Ref # 59266A)	59266-0764	1
SPACER (Ref # 92026)	92026-0916	1
RING-SNAP (Ref # 92033)	92033-0849	2
PIN,DOWEL,8X14 (Ref # 92043)	92043-1750	2
SEAL-OIL,TC9 35X62X9 (Ref # 92049)	92049-0856	2
SEAL-OIL,TC7 45X72X7 (Ref # 92049A)	92049-0857	1
RING-O (Ref # 92055)	92055-0862	2
RING-O,22.1X1.9 (Ref # 92055A)	92055-1617	1
RING-O (Ref # 92055B)	92055-1719	1
PLUG,M18 (Ref # 92066)	92066-0982	2
BAND,L=186 (Ref # 92072)	92072-056	1
BOLT,FLANGED,8X30 (Ref # 92154)	92154-4354	12
BOLT,FLANGED,8X16 (Ref # 92154A)	92154-4355	1
CLAMP (Ref # 92170)	92170-2082	1
TUBE,BREATHER (Ref # 92192)	92192-1341	1
NUT,M30 (Ref # 92210)	92210-1884	1