

# 2024 JET SKI® ULTRA® 310LX-S

## PARTS DIAGRAM

### Owner's Tools

F3182

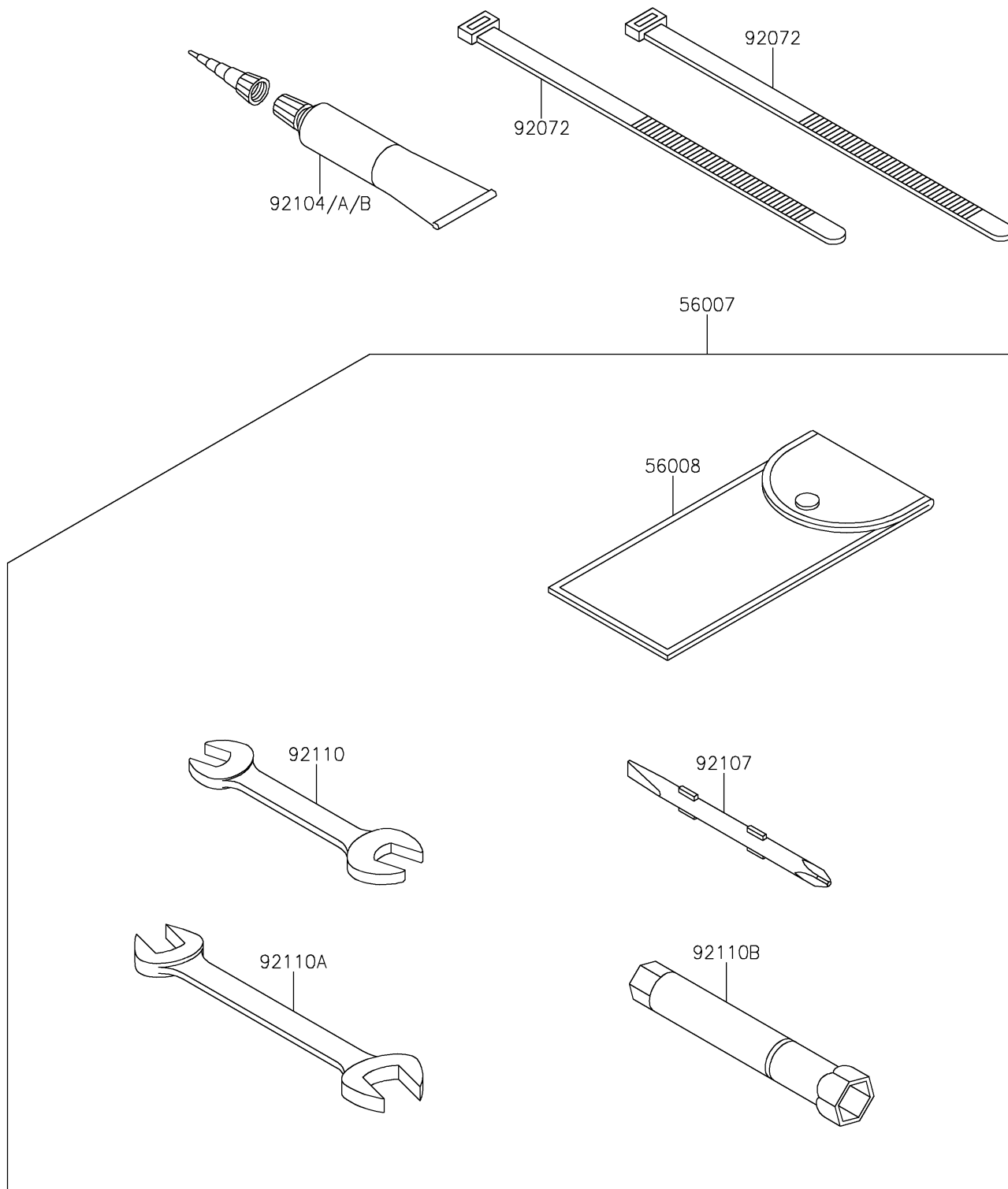

# 2024 JET SKI® ULTRA® 310LX-S

## PARTS LIST Owner's Tools



**ITEM NAME**

**PART NUMBER**

**QUANTITY**

---