

# 2024 JET SKI® ULTRA® 310LX-S

## PARTS DIAGRAM

### Handlebar

F3172

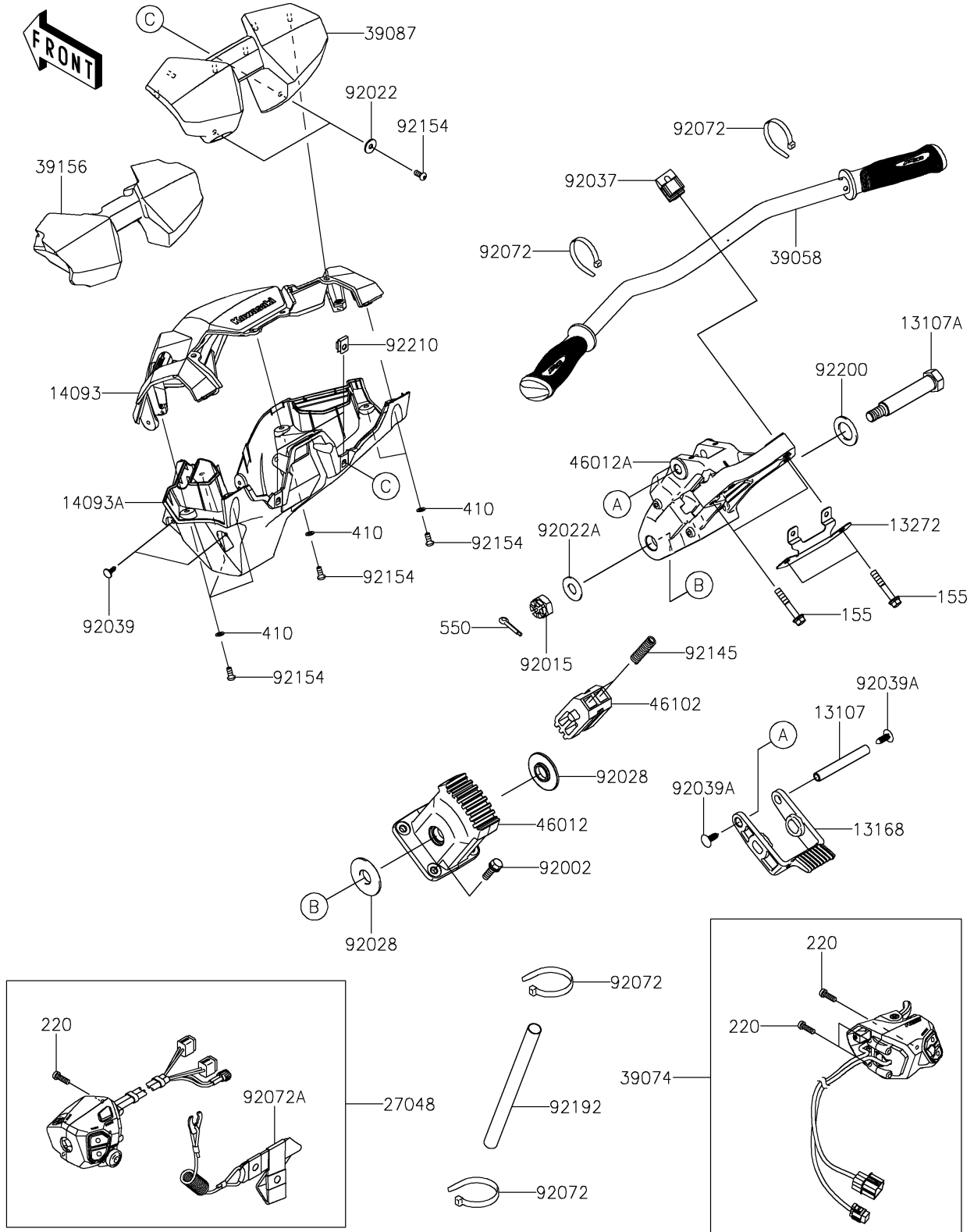

# 2024 JET SKI® ULTRA® 310LX-S

## PARTS LIST

### Handlebar

ITEM NAME	PART NUMBER	QUANTITY
-----------	-------------	----------

---