

2024 JET SKI® ULTRA® 310LX-S

PARTS DIAGRAM

Drive Shaft

E3134

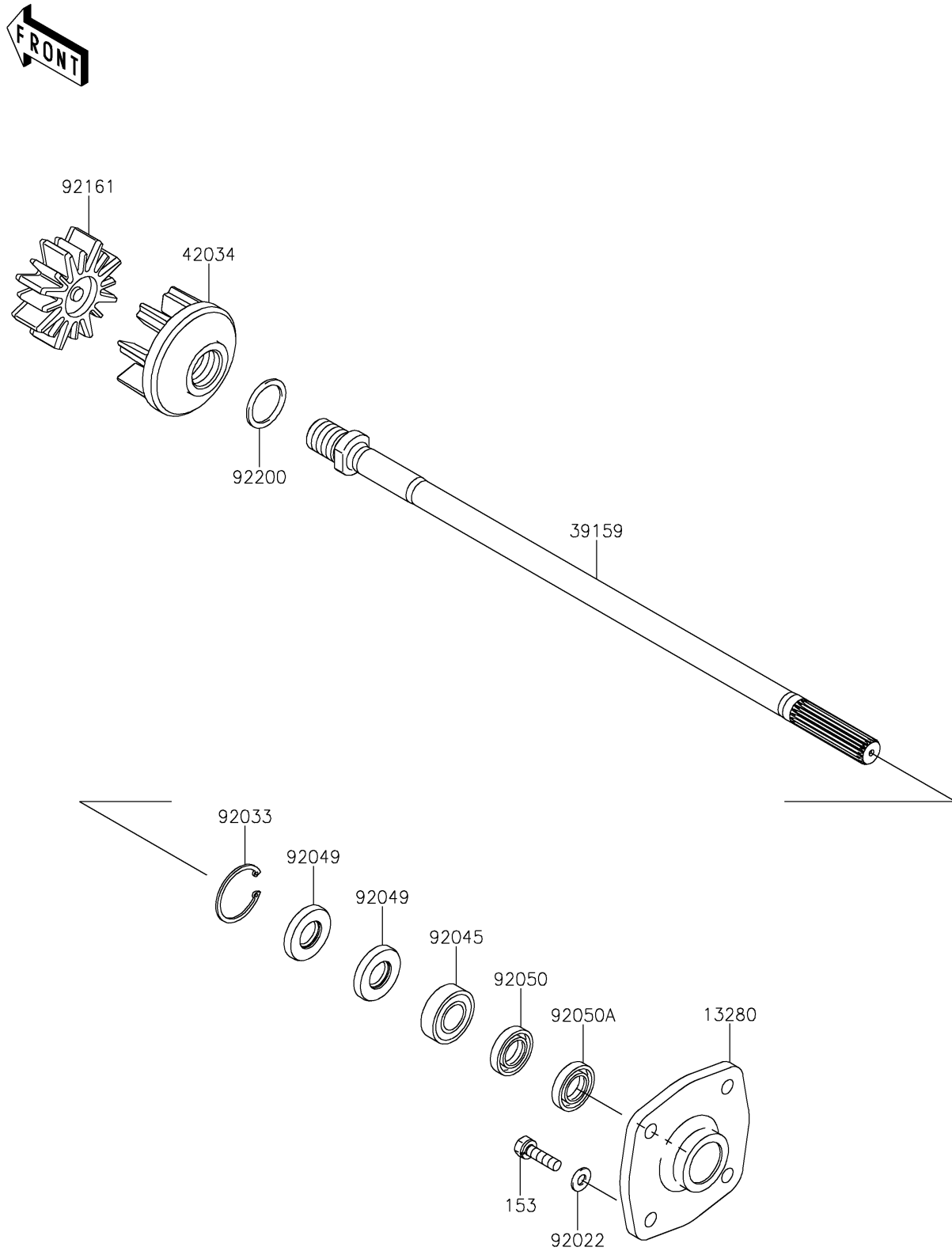

2024 JET SKI® ULTRA® 310LX-S

PARTS LIST

Drive Shaft

ITEM NAME	PART NUMBER	QUANTITY
-----------	-------------	----------
