

2026 VULCAN® S

PARTS DIAGRAM

Rear Brake

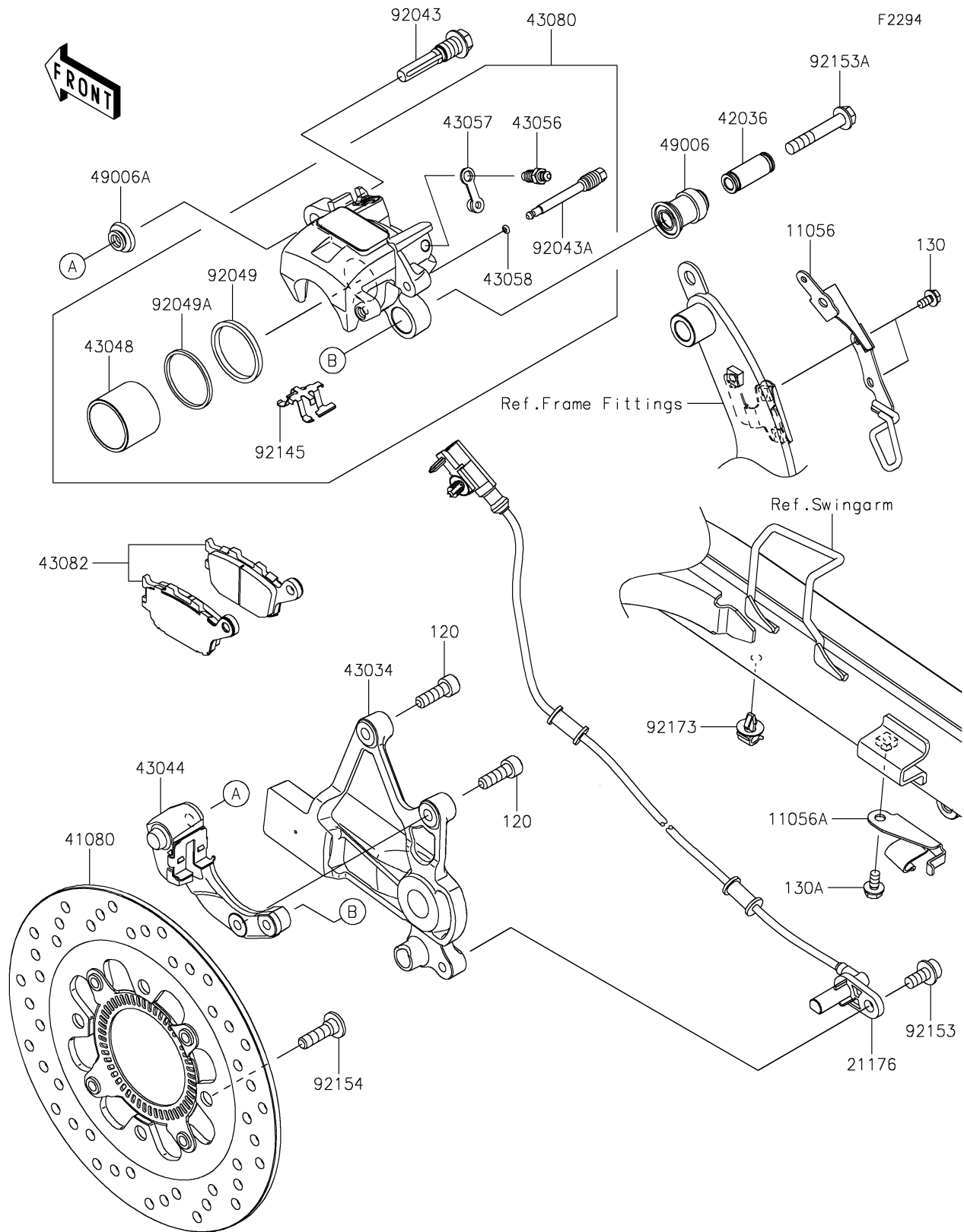

2026 VULCAN® S

PARTS LIST

Rear Brake

ITEM NAME

PART NUMBER

QUANTITY
